



YOUR LIGHT



INTERIOR LIGHTING

4 – 189



BATHROOM

190 – 253



SYSTEMS

254 – 277



LIGHT IS OUTSIDE

278 – 349

- eingebaute LED
built-in LED
- E27 GU10 Fassung für austauschbare Leuchtmittel
socket for exchangeable bulbs
- dimmbar
dimmable
- inklusive Dimmer
dimmer included
- inklusive Fernbedienung
remote control included
- Smart Home Steuerung optional
smart home control optionally
- inklusive Schalter
switch on/off included
- Höhe einstellbar
Height adjustable
- stufenlose Höhenverstellung
height infinitely adjustable
- EASY-LIFT Höhenverstellung
EASY-LIFT height adjustment
- inklusive Bewegungsmelder
motion sensor included
- Schutzart
ingress protection
- Stoßfestigkeitsgrad
impact protection
- YOUR LIGHT Plus

INTERIOR LIGHTING



Leuchtenübersicht Innenleuchten
Overview interior lighting

NEW

INDEX

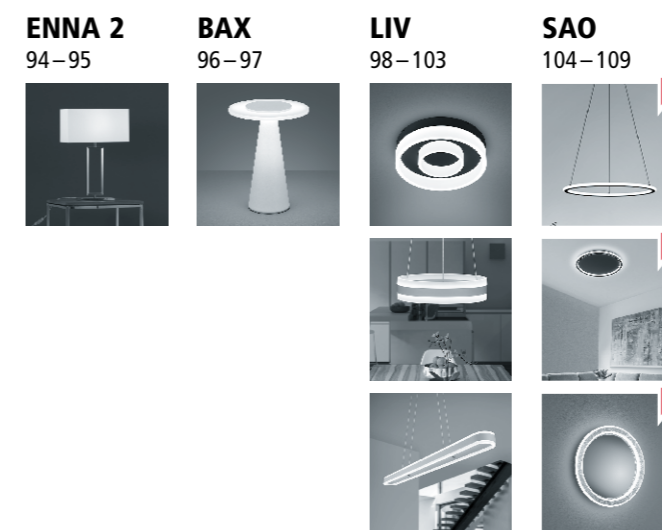
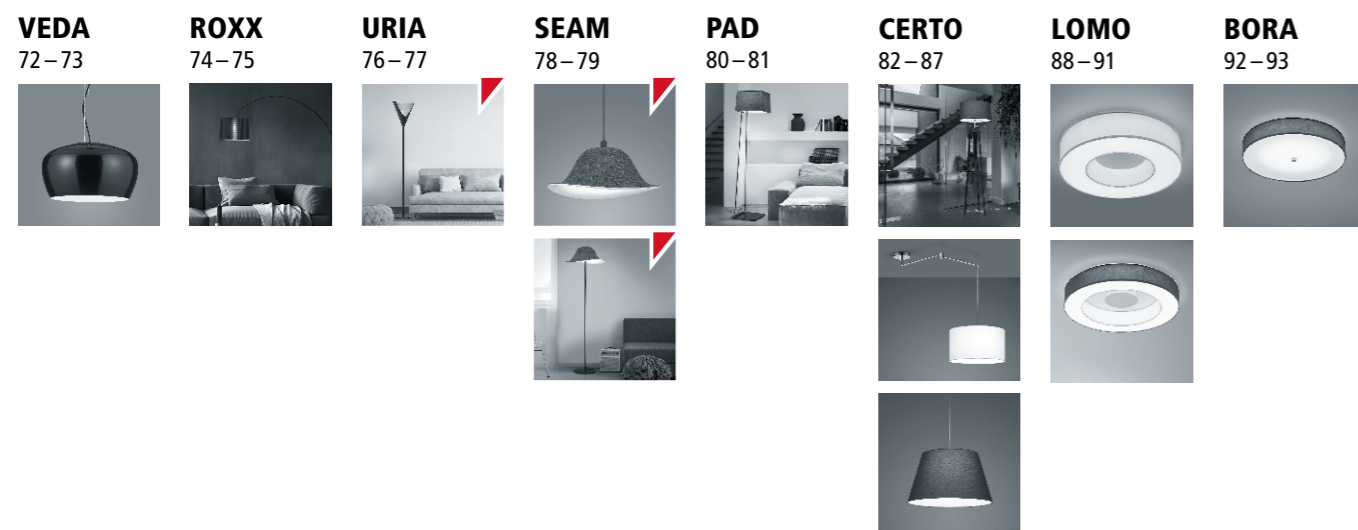
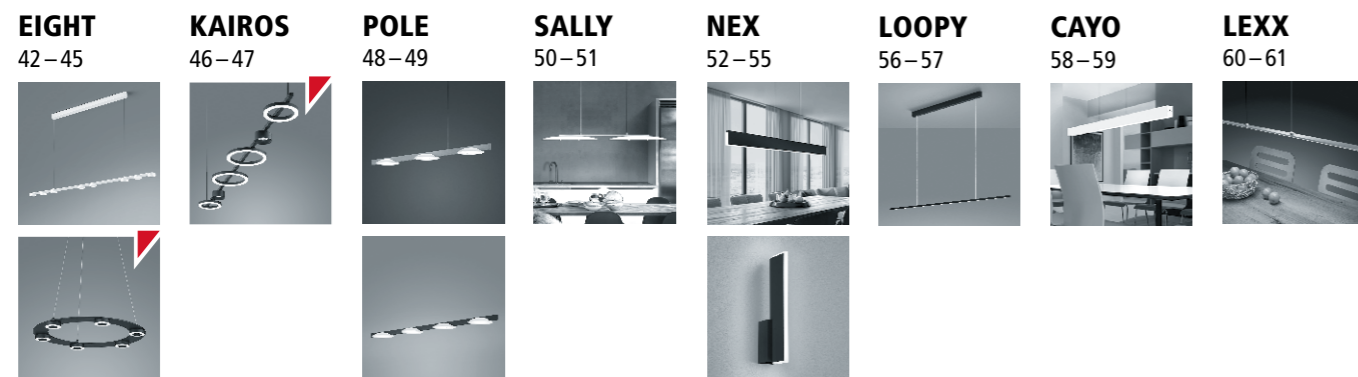
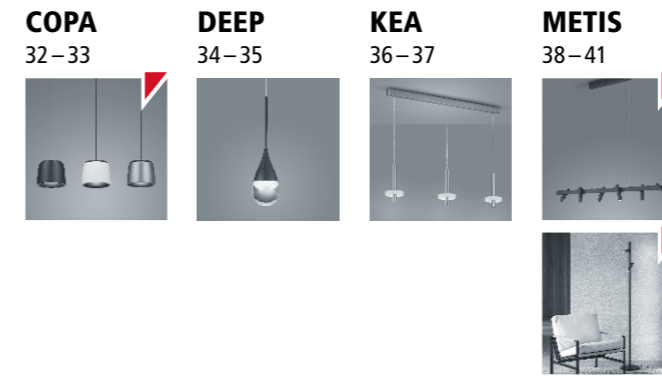
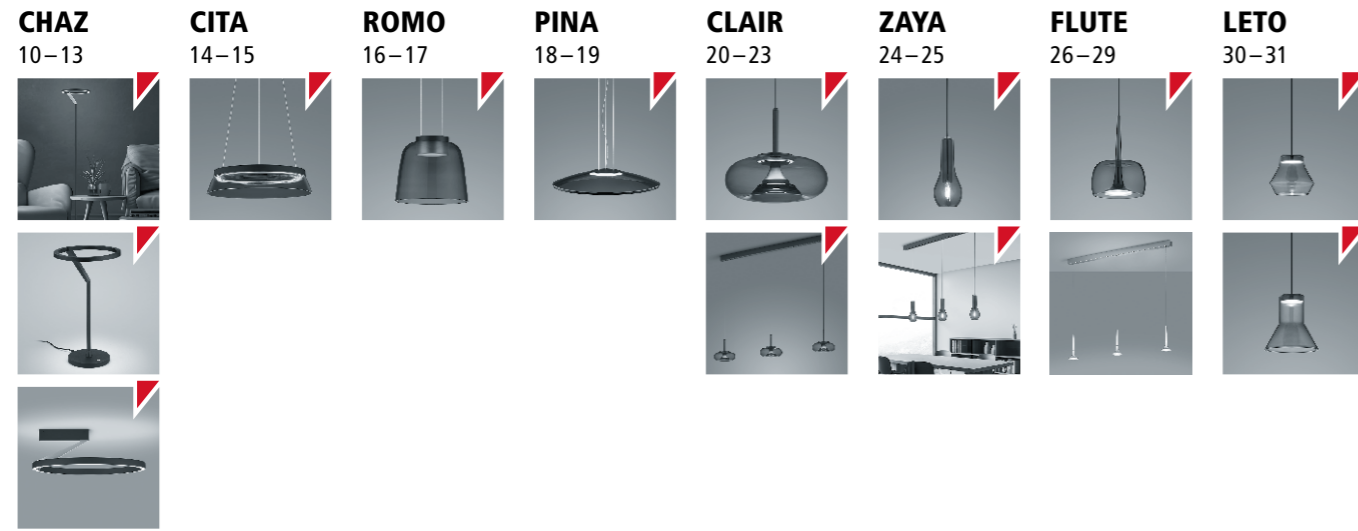

ADEO	144-145
BAX	96-97
BELOS	130-131
BORA	92-93
CANIO	134-135
CAYO	58-59
CERTO	82-87
CHAZ	10-13
CITA	14-15
CLAIR	20-23
COPA	32-33
COR	142-143
COSI	114-115
DAYO	140-141
DEEP	34-35
DEX	138-139
DORA	156-157
DORO	68-71
EIGHT	42-45
ENIO	162-163
ENNA 2	94-95
FLUTE	26-29
FOSCA	148-149
GOTO	168-169
HELEN	110-111
INEO	164-165
ITO	188-189
KAIROS	46-47
KARI	158-161
KEA	36-37
KURVO	66-67
LETO	30-31
LEXX	60-61
LICA	124-125
LIV	98-103
LOMO	88-91
LOOPY	56-57
METIS	38-41
MOYA	62-63
NEX	52-55
NOG	176-177
ONTO	184-185
PAD	80-81
PAX	170-171
PINA	18-19
POLE	48-49
PONT	150-151 / 172-173
RACK	120-123
RIWA	166-167
ROMO	16-17
ROTA	174-175
ROXX	74-75
SALLY	50-51
SAO	104-109
SEAM	78-79
SENT	186-187
SIMO	132-133
SIRI	152-153
SIRI LED	154-155
SKA	182-183
SONA	112-113
TAIL	136-137
TAMO	126-127
TANA	128-129
TUDO	178-181
URIA	76-77
VEDA	72-73
VENTA	64-65
VIRTO	116-119
YONA	146-147
ZAYA	24-25

Leuchtenübersicht Innenleuchten
Overview interior lighting

NEW

INDEX

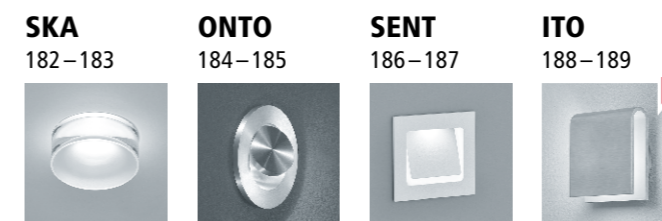
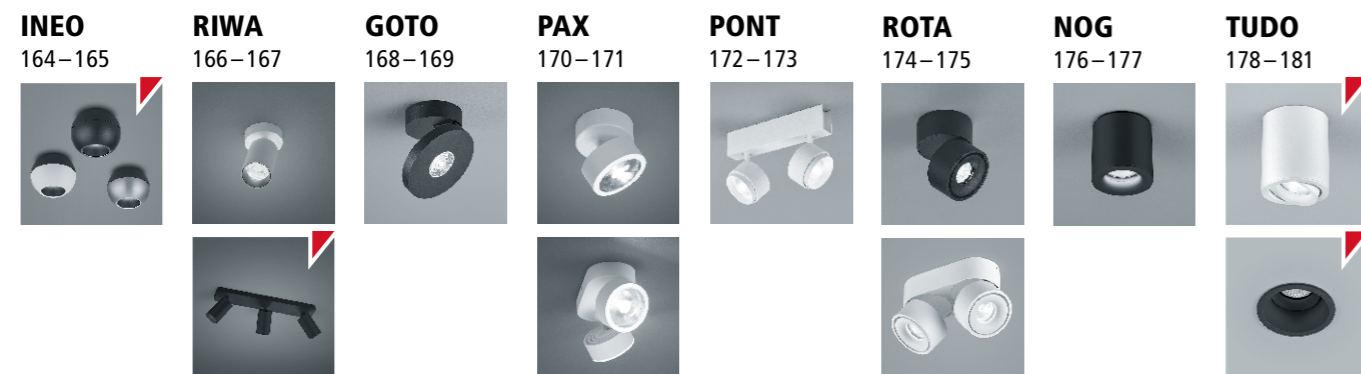
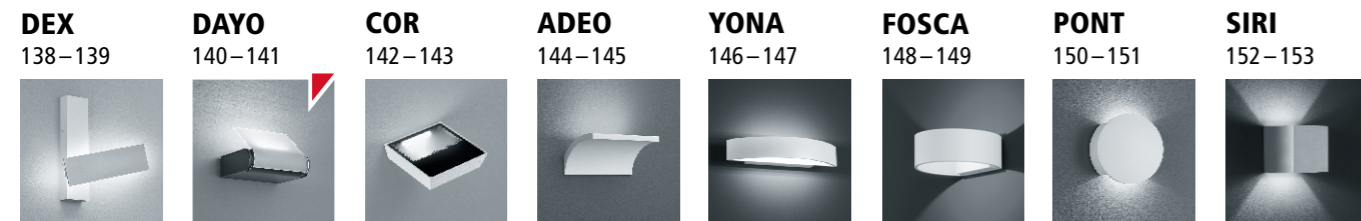
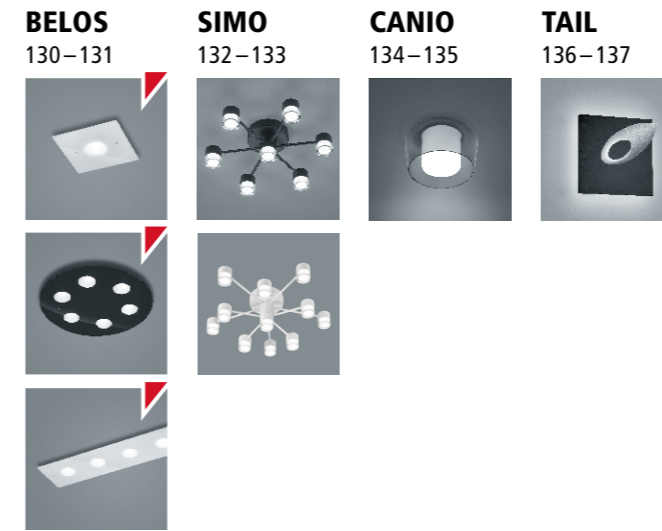
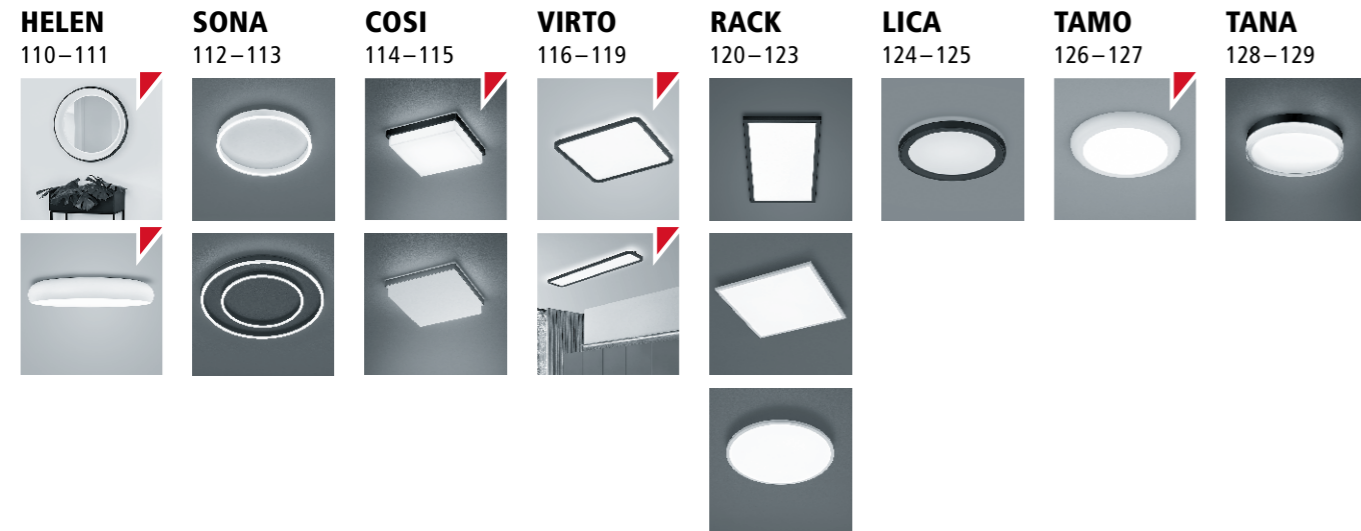

CHAZ

LED  IP20 

Acryldiffusor satiniert
acrylic diffuser satinised



12 W, 2700 K, B 1360 / N 820 lm, CRI > 90

mattschwarz / black mat

19/2402.22

mattschwarz - mattgold / black mat - gold mat

19/2402.28



13,5 W, 2700 K, B 1530 / N 920 lm, CRI > 90

mattschwarz / black mat

17/2402.22

mattschwarz - mattgold / black mat - gold mat

17/2402.28

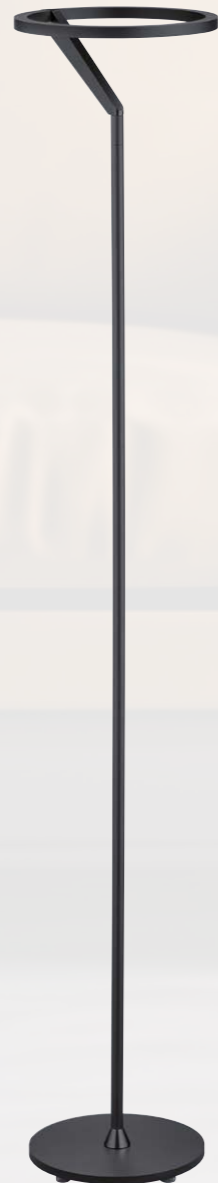



CHAZ

LED  IP20  YL Plus

Acryldiffusor satiniert
acrylic diffuser satinised

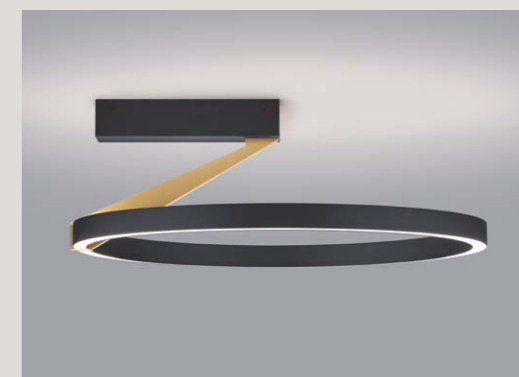

25 W, 2700 K, B 2840 / N 1930 lm, CRI > 90

Lichtverteilung direkt / indirekt
light distribution direct / indirect

mattschwarz / black mat

25/2402.22

mattschwarz - mattgold / black mat - gold mat

25/2402.28

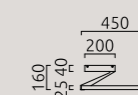

11 W, 2700 K, B 1100 / N 660 lm, CRI > 90

mattschwarz / black mat

18/2402.22

mattschwarz - mattgold / black mat - gold mat

18/2402.28

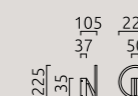

CITA

LED    IP20 

mundgeblasenes Glas
mouth-blown glass

38 W, 2700 K, B 4390 / N 2380 lm, CRI > 90

chrom / chrome
Glas - klar / glass - clear
16/2306.04/5328

mattschwarz / black mat
Glas grau / glass grey
16/2306.22/5329

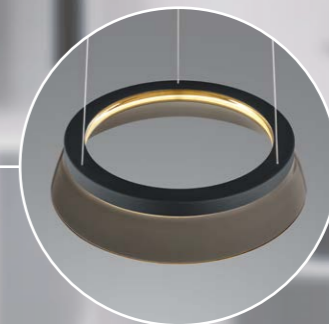
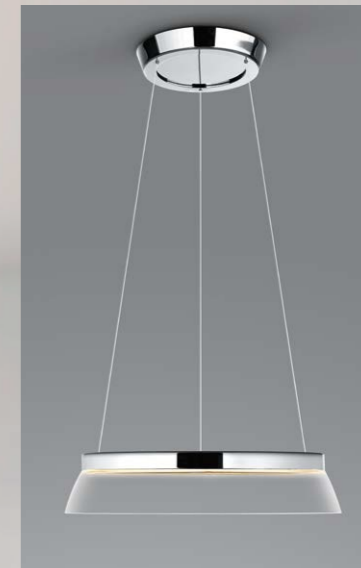
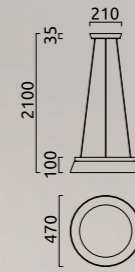

ROMO



25 W, 2700 K, B 2340 / N 1810 lm, CRI > 90

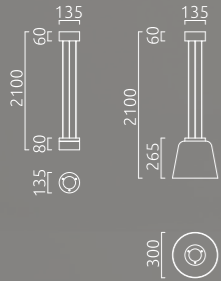

schwarzchrom / black chrome

16/2404.64

schwarzchrom / black chrome

Glas rauchgrau / glass smokey grey

16/2404.64/5346

mattschwarz - mattgold / black mat - gold mat

16/2404.28

mattschwarz - mattgold / black mat - gold mat

Glas rauchgrau / glass smokey grey

16/2404.28/5346





PINA



mattschwarz
black mat

21 W, 2700 K, B 2210 / N 1760 lm, CRI > 90

Glas grau / glass grey
16/2314.22/5326

Glas bronze / glass bronze
16/2314.22/5327

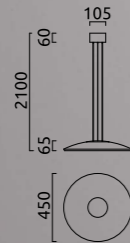

CLAIR



Kristallglas rauchgrau
crystal glass smokey grey

17 W, 2700 K, B 1750 / N 1360 lm, CRI > 90

mattschwarz / black mat

16/2403.22

mattschwarz - mattgold / black mat - gold mat

16/2403.28



www.helestra.de/clair

CLAIR

LED   IP20 

Kristallglas rauchgrau
crystal glass smokey grey



27 W, 2700 K, B 2780 / N 2170 lm, CRI > 90

mattschwarz / black mat
36/2403.22

mattschwarz - mattgold / black mat - gold mat
36/2403.28

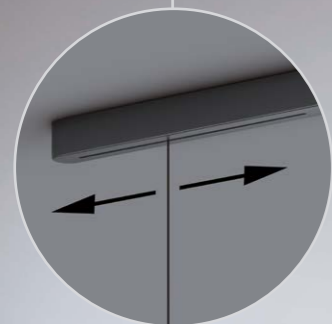
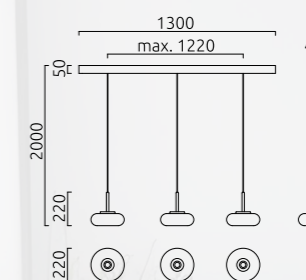

ZAYA

E27 ↑ IP20 YL Plus

schwarzchrom
Kristallglas rauchgrau
black chrome
crystal glass smokey grey

Leuchtmittel nicht im Lieferumfang
bulb not included

1 x E27
16/2405.64/5345

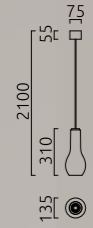

3 x E27
36/2405.64/5345

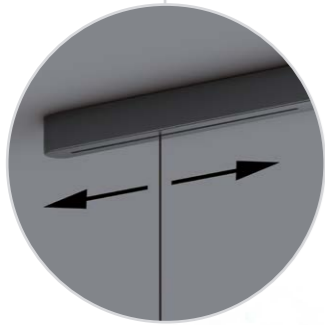
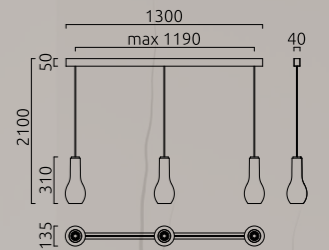

FLUTE

LED   IP20

Acryldiffusor satiniert
optional Glas klar oder grau
acrylic diffuser satinised
optional glass clear or grey

Gläser bitte separat bestellen /
please order glasses separately
5284 Glas klar / glass clear
5285 Glas grau / glass grey

8 W, 2800 K, B 880 / N 570 lm, CRI > 90

chrom / chrome
16/2001.04

schwarzchrom / black chrome
16/2001.64

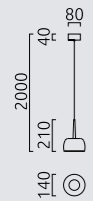

19 W, 2800 K, B 2140 / N 1320 lm, CRI > 90

chrom / chrome
36/2002.04

schwarzchrom / black chrome
36/2002.64

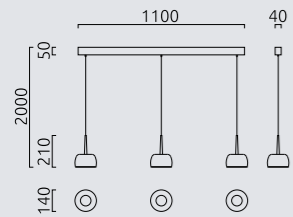



FLUTE

LED    IP20

Acryldiffusor satiniert
acrylic diffuser satinised

8 W, 2800 K, B 880 / N 570 lm, CRI > 90

chrom / chrome
16/2001.04

schwarzchrom / black chrome
16/2001.64



19 W, 2800 K, B 2140 / N 1320 lm, CRI > 90

chrom / chrome
36/2002.04

schwarzchrom / black chrome
36/2002.64

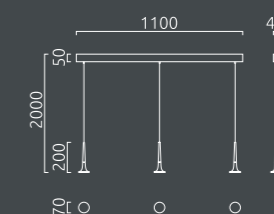

LETO

LED ↑ IP20 YL Plus

mattschwarz
Glas grau
black mat
glass grey

6 W, 2700 K, B 440 / N 380 lm, CRI > 90

16/2315.22/5324

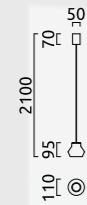

16/2315.22/5325

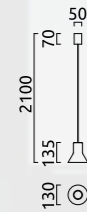



COPA

LED IP20



16 W, 2700 K, B 1530 / N 1130 lm, CRI > 90
mattweiß / white mat

- Reflektor / reflector
- 16/2302.07-07 weiß / white
 - 16/2302.07-09 gold / gold
 - 16/2302.07-22 schwarz / black

- mattschwarz / black mat
- Reflektor / reflector
- 16/2302.22-07 weiß / white
 - 16/2302.22-09 gold / gold
 - 16/2302.22-22 schwarz / black



DEEP

LED ↑ IP20

Glas teilsatiniert
glass partially satinised

5,5 W, 2700 K, B 570 / N 450 lm, CRI > 95

mattgold / gold mat
16/2110.09

mattschwarz / black mat
16/2110.22



KEA



Glas opal weiß
Abstrahlwinkel 50°
glass opal white
beam angle 50°



32 W, 2700 K, B 3450 / N 1710 lm, CRI > 90

mattnickel / nickel mat

66/2108.06/5303

mattschwarz / black mat

66/2108.22/5303

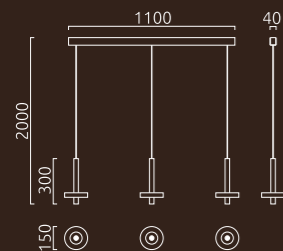

METIS

LED    IP20 

schwenkbar
tiltable

43 W, 2700 K, B 4980 / N 3480 lm, CRI > 90

mattschwarz / black mat
96/2311.22

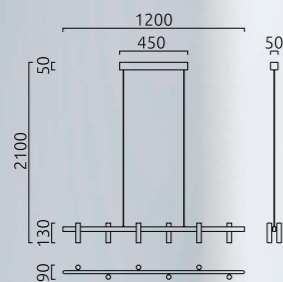

METIS



schwenkbar
tiltable

18 W, 2700 K, B 2110 / N 1780 lm, CRI > 90



mattweiß / white mat
27/2311.07

mattschwarz / black mat
27/2311.22





EIGHT

LED    

Acrylglas satiniert
acrylic diffuser satinised

35 W, 2700 K, B 3820 / N 2030 lm, CRI > 90



mattweiß / white mat
16/2214.07
mattschwarz / black mat
16/2214.22

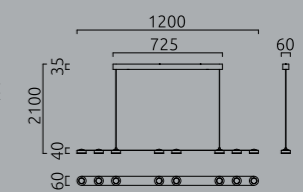

EIGHT



mattschwarz
Acrylglas satiniert
black mat
acrylic diffuser satinised



26 W, 2700 K, B 2850 / N 1520 lm, CRI > 90
66/2313.22

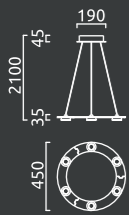



KAIROS

LED    

mattschwarz
Acryl satiniert
black mat
acrylic satinised

36 W, 2700 K, B 4090 / N 2720 lm, CRI > 90
66/2307.22

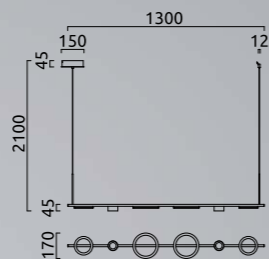



POLE

LED    IP20

Glas satiniert
glass satinised

28 W, 2700 K, B 3940 / N 2160 lm, CRI > 90
 mattnickel eloxiert / nickel mat anodised
36/1901.18
 mattschwarz eloxiert / black mat anodised
36/1901.22

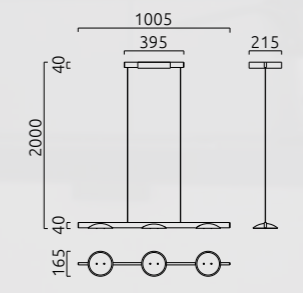

41 W, 2700 K, B 5250 / N 2880 lm, CRI > 90
 mattnickel eloxiert / nickel mat anodised
46/1901.18
 mattschwarz eloxiert / black mat anodised
46/1901.22

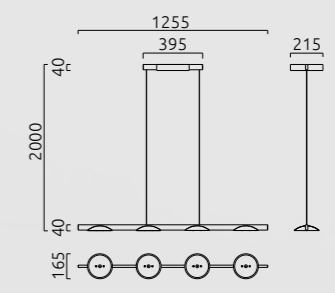

SALLY

LED    IP20



mattnickel - chrom
Glas satiniert
nickel mat - chrome
glass satinised

22 W, 2800 K, B 2460 / N 1890 lm, CRI > 90
26/1641.27/5210

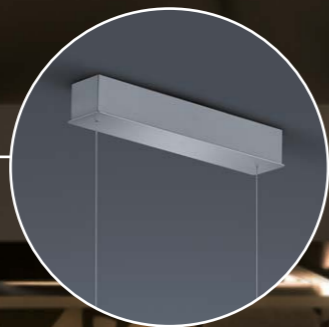
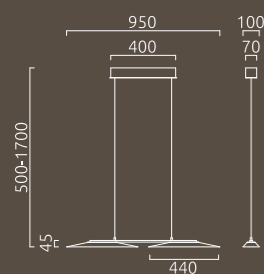

www.helestra.de/sally

NEX

LED    IP20

mattschwarz
Acryldiffusor satiniert
black mat
acrylic diffuser satinised



45 W, 2700 K, B 5900 / N 2820 lm, CRI > 90
16/2007.22

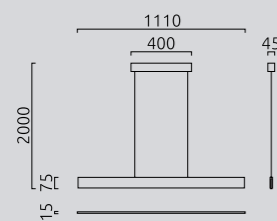



NEX

LED IP20

mattschwarz
Acryldiffusor satiniert
black mat
acrylic diffuser satinised



12 W, 2700 K, B 1620 / N 1150, CRI > 90
18/2007.22



LOOPY

LED   IP20

mattschwarz
Acryldiffusor satiniert
black mat
acrylic diffuser satinised

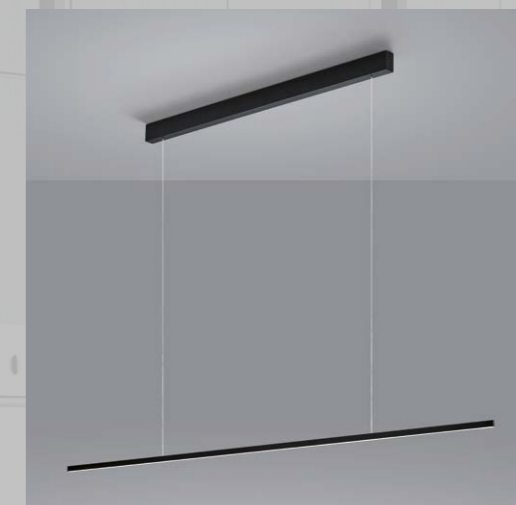

22 W, 2700 K, B 2370 / N 970 lm, CRI > 90
16/2109.22

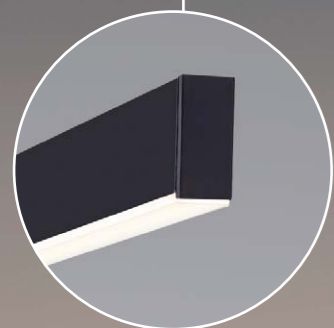
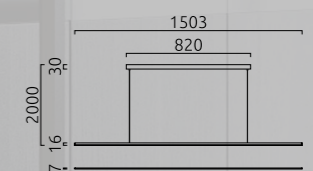



CAYO



inkl. Sensordimmer (Gestensteuerung)
Up- und Downlight getrennt schalt- und dimmbar
dimmable with gesture control
Up- and Downlight separately controllable

50 W, 2700 K, B 5780 / N 2250 lm, CRI > 90



mattweiß / white mat
26/2009.07

mattschwarz / black mat
26/2009.22

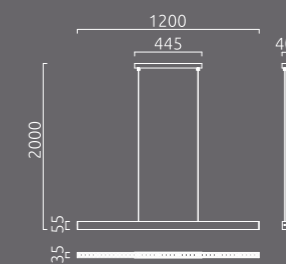

LEXX

LED   IP30

mattnickel eloxiert - chrom
Acryldiffusor satiniert
nickel mat anodised - chrome
acrylic diffuser satinised

23 W, 2700 K, B 2630 / N 1820 lm, CRI > 85



16/1504.19

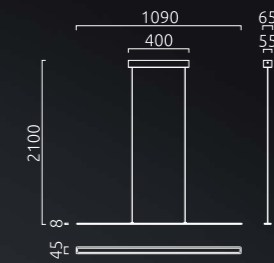

16/1644.19

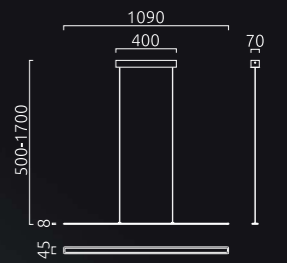

MOYA

LED   IP30



aluminium matt
Acrylglas satiniert
aluminium mat
acrylic glass satinised

29 W, 2800 K, B 3110 / N 1740 lm, CRI > 90
16/1722.26

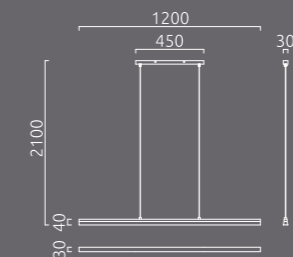

VENTA

LED  IP30

Acryldiffusor satiniert
acrylic diffuser satinised

31 W, 2700 K, B 4790 / N 2690 lm, CRI > 90

mattnickel - chrom / nickel mat - chrome
17/1505.19

mattschwarz / black mat
17/1505.22

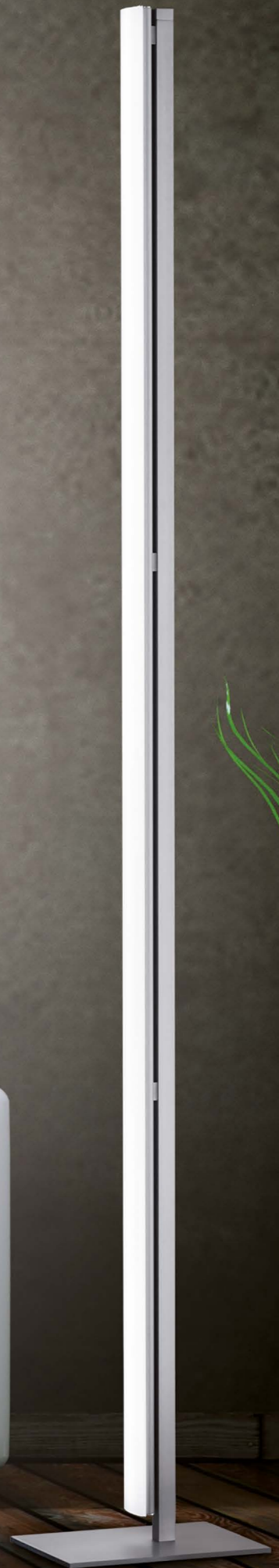
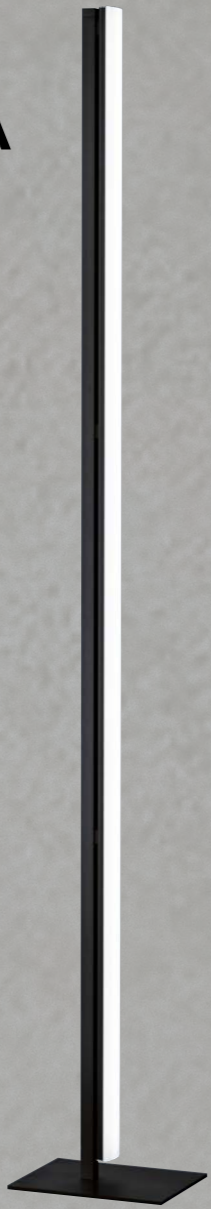
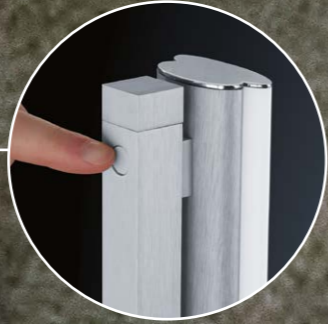
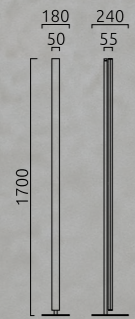

KURVO

LED  IP30

Acryldiffusor satiniert
acrylic diffuser satinised



47 W, 2700 K, B 5390 / N 1620 lm, CRI > 85

mattnickel - chrom / nickel mat - chrome
27/1502.19

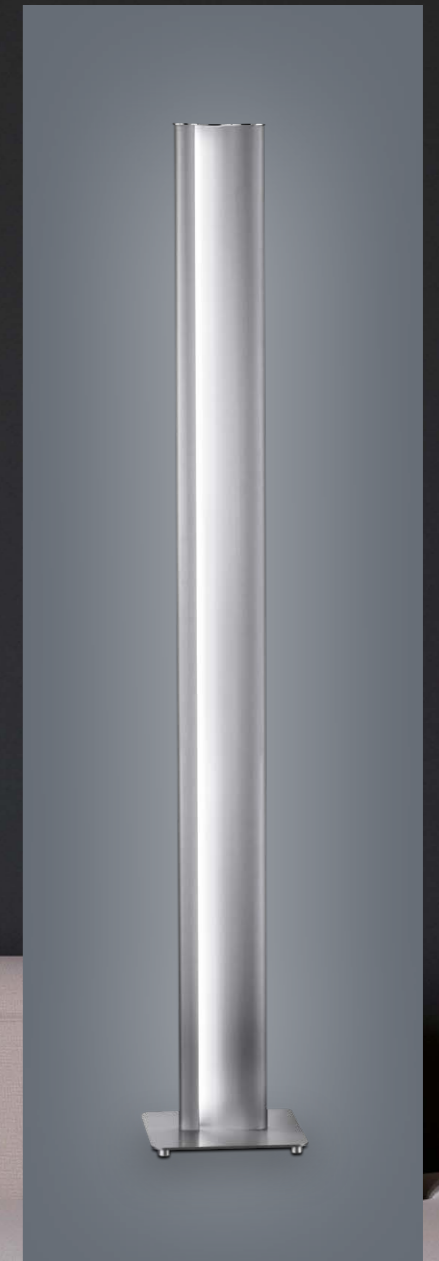
mattschwarz - chrom / black mat - chrome
271502.22



DORO

E27   IP20

1 x E27

Schirm Acryl weiß
shade acrylic white

weiß - chrom / white - chrome
17/1240.84/5045

schwarz - chrom / black - chrome
17/1240.34/5045

Schirm Acryl schwarz
shade acrylic black

schwarz - chrom / black - chrome
17/1240.34/5096

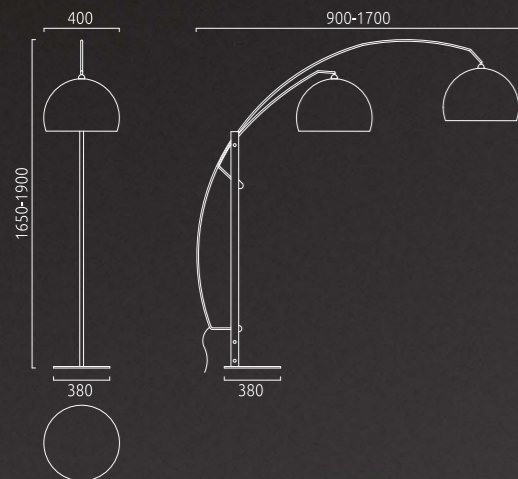

Leuchtmittel nicht im Lieferumfang
bulb not included



DORO

E27 ↑ IP20

mattschwarz
black mat

1 x E27

Textilkabel schwarz / textile cord black

Ø 40

16/2340.22/5045 Acryl weiß / acrylic white
16/2340.22/5096 Acryl schwarz / acrylic black

Ø 50

16/2340.22/5097 Acryl weiß / acrylic white
16/2340.22/5098 Acryl schwarz / acrylic black

Textilkabel rot / textile cord red

Ø 40

16/2340.75/5045 Acryl weiß / acrylic white
16/2340.75/5096 Acryl schwarz / acrylic black

Ø 50

16/2340.75/5097 Acryl weiß / acrylic white
16/2340.75/5098 Acryl schwarz / acrylic black

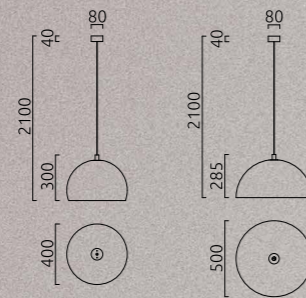

Leuchtmittel nicht im Lieferumfang
bulb not included



VEDA

E27 ↑ IP20

mattschwarz eloxiert
black mat anodised

1 x E27

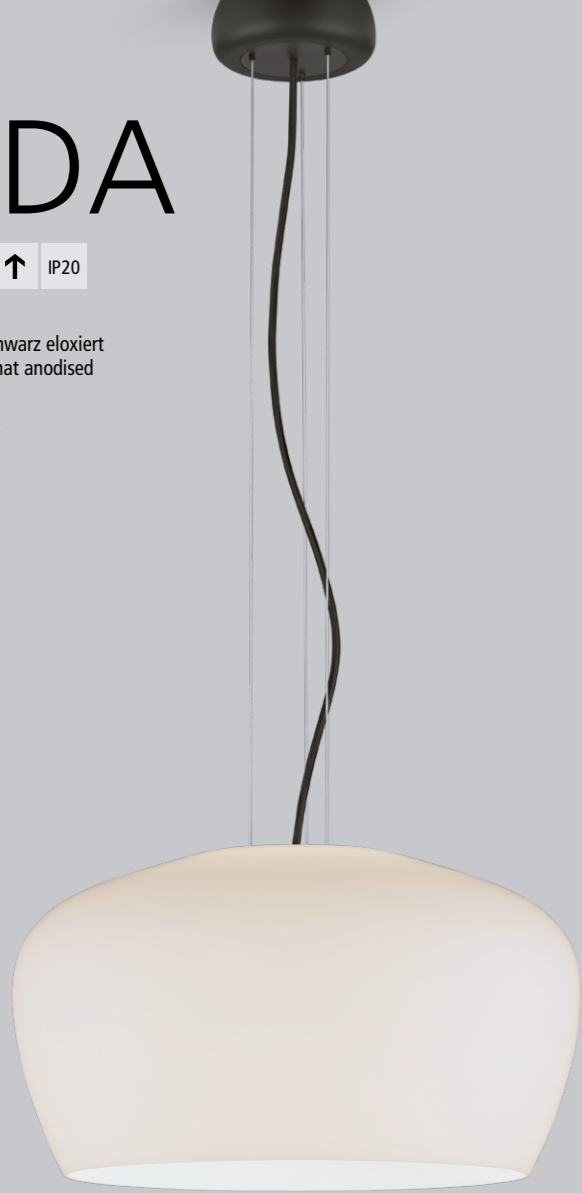

Opalglas weiß / glass opal white
16/2107.22/5300

Opalglas schwarz lackiert / glass opal black lacquered
16/2107.22/5301

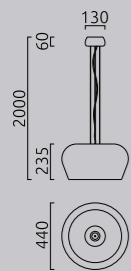

Leuchtmittel nicht im Lieferumfang
bulb not included



www.helestra.de/veda



ROXX

E27  IP20

Schirm PVC
schwarz mit geriffeltem Schirm
shade PVC
black with ribbed shade

1 x E27
17/1036.22

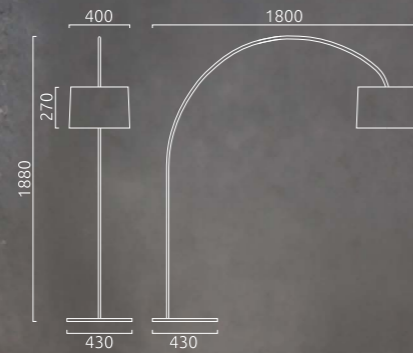

Leuchtmittel nicht im Lieferumfang
bulb not included



URIA

E27  IP20 **YL**
Plus

mattschwarz - blattgold
black mat - gold leaf

1x E27
17/2310.28

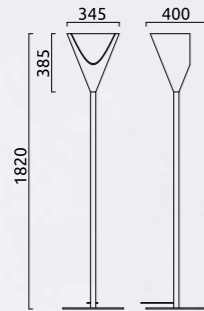

Leuchtmittel nicht im Lieferumfang
bulb not included



SEAM

E27 IP20 YL Plus

mattschwarz
Schirm Filz anthrazit meliert
black mat
shade felt anthracite

Leuchtmittel nicht im Lieferumfang
bulb not included

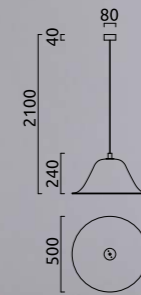

1 x E27
16/2304.22 Textilkabel schwarz / textile cord black
16/2304.75 Textilkabel rot / textile cord red



2 x E27
27/2304.22

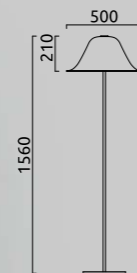



PAD

E27  IP20 **YL**
Plus

mattschwarz
Marmorfuß schwarz
black mat
black marble base

1 x E27



Textilschirm weiß / fabric shade white
17/2008.22/9319

Textilschirm schwarz / fabric shade black
17/2008.22/9320

Leuchtmittel nicht im Lieferumfang
bulb not included



CERTO

E27  IP20

mattschwarz - chrom
black mat - chrome

1 x E27

Schirm Chintz weiß / shade chintz white
17/1849.34/9290

Schirm Chintz anthrazit / shade chintz anthracite
17/1849.34/9289



Leuchtmittel nicht im Lieferumfang
bulb not included



CERTO

E27 ↑ IP20

chrom
dreh- und schwenkbar
chrome
rotatable and tiltable

1 x E27



Schirm Chintz weiß / shade chintz white
16/1847.04/9290



Schirm Chintz anthrazit / shade chintz anthracite
16/1847.04/9289



Schirm Chintz mocca / shade chintz mocca
16/1847.04/9288

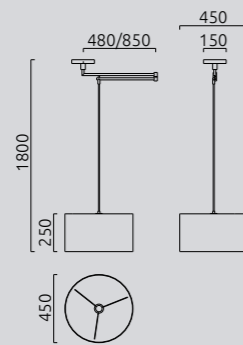

Schirm Chintz weiß / shade chintz white
16/1847.04/9276



Schirm Chintz anthrazit / shade chintz anthracite
16/1847.04/9283

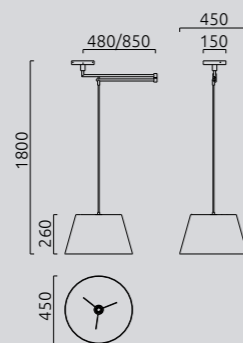

Leuchtmittel nicht im Lieferumfang
bulb not included





CERTO

E27 ↑ IP20

chrom
dreh- und schwenkbar
chrome
rotatable and tiltable

2 x E27



Schirm Chintz weiß / shade chintz white
26/1847.04/9290

Schirm Chintz anthrazit / shade chintz anthracite
26/1847.04/9289

Schirm Chintz mocca / shade chintz mocca
26/1847.04/9288

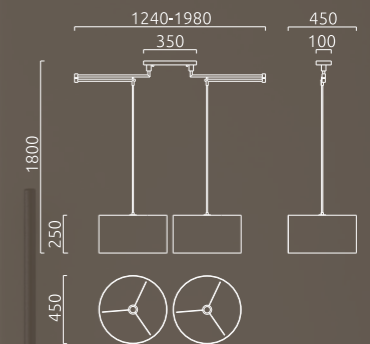

Schirm Chintz weiß / shade chintz white
26/1847.04/9276

Schirm Chintz anthrazit / shade chintz anthracite
26/1847.04/9283

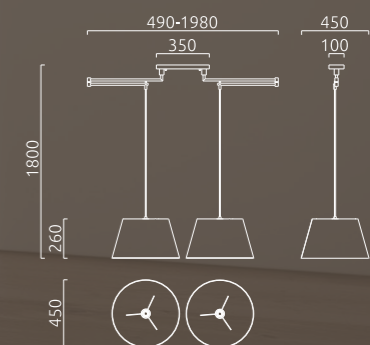

LOMO

LED   IP20

mattweiß
white mat

34 W, 2800 K, B 4030 / N 2500 lm, CRI > 90

Schirm Chintz weiß / shade chintz white
15/1800.07/9277

Schirm Chintz mocca / shade chintz mocca
15/1800.07/9278

Schirm Chintz anthrazit / shade chintz anthracite
15/1800.07/9281





LOMO

LED   IP20

mattweiß
white mat

45 W, 2800 K, B 5220 / N 2840 lm, CRI > 90



Schirm Chintz weiß
shade chintz white
15/1900.07/9304



Schirm Chintz anthrazit
shade chintz anthracite
15/1900.07/9305



Schirm Chintz mocca
shade chintz mocca
15/1900.07/9306





BORA

LED   IP20

mattnickel eloxiert - chrom
Acryldiffusor satiniert
nickel mat anodised - chrome
acrylic diffuser satinised

31 W, 2800 K, B 3510 / N 2280 lm, CRI > 90



Schirm Chintz weiß / shade chintz white
15/1745.19/9258

Schirm Chintz mocca / shade chintz mocca
15/1745.19/9259

Schirm Chintz anthrazit / shade chintz anthracite
15/1745.19/9292

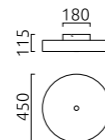

ENNA 2

E14 E27  IP20

blanknickel
Schirm, Chintz weiß
nickel polished
shade, chintz white



1 x E14
19/1138.10

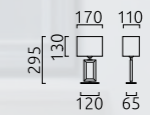

1 x E27
19/1139.10

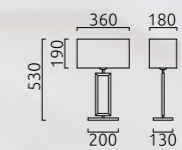

Leuchtmittel nicht im Lieferumfang
bulb not included



BAX

LED  IP20

Acryldiffusor satiniert
acrylic diffuser satinised

10 W, 2700 K, B 1220 / N 780 lm, CRI > 85

mattweiß / white mat

19/1943.07

mattmessing-schwarz / brass mat-black

19/1943.28



LIV

LED   IP30

Acryldiffusor satiniert
acrylic diffuser satinised



10 W, 2900 K, B 1260 / N 460 lm, CRI > 90

mattweiß / white mat
15/1732.07

mattschwarz / black mat
15/1732.22



17 W, 2900 K, B 2090 / N 740 lm, CRI > 90

mattweiß / white mat
15/1632.07

mattschwarz / black mat
15/1632.22



36 W, 2900 K, B 4630 / N 2340 lm, CRI > 90

mattweiß / white mat
25/1734.07

mattschwarz / black mat
25/1734.22





LIV

LED    IP20

Acryldiffusor satiniert
acrylic diffuser satinised



49 W, 2900 K, B 5310 / N 3650 lm, CRI > 90

mattweiß / white mat

26/1692.07

mattschwarz / black mat

26/1692.22



70 W, 2900 K, B 7710 / N 5070 lm, CRI > 90

mattweiß / white mat

26/1792.07

mattschwarz / black mat

26/1792.22

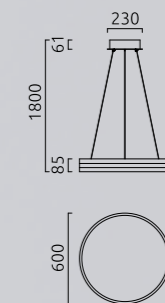

LIV

LED    IP20

mattweiß
Acryldiffusor satiniert
white mat
acrylic diffuser satinised

55 W, 2900 K, B 6480 / N 3910 lm, CRI > 90
26/1892.07

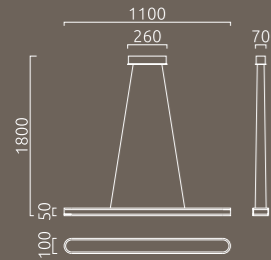

www.helestra.de/liv

SAO



Acryldiffusor satiniert
acrylic diffuser satinised



40 W, 2700 K, B 4470 / N 3710 lm, CRI > 90

mattweiß / white mat

26/2430.07

mattschwarz / black mat

26/2430.22



60 W, 2700 K, B 6700 / N 5550 lm, CRI > 90

mattweiß / white mat

26/2431.07

mattschwarz / black mat

26/2431.22

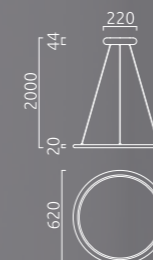



SAO

LED   IP20 

Acryldiffusor satiniert
acrylic diffuser satinised

40 W, 2700 K, B 4470 / N 3710 lm, CRI > 90

mattweiß / white mat
25/2330.07

blattgold / gold leaf
25/2330.09

mattschwarz / black mat
25/2330.22

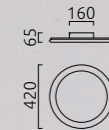

60 W, 2700 K, B 6700 / N 5550 lm, CRI > 90

mattweiß / white mat
25/2331.07

blattgold / gold leaf
25/2331.09

mattschwarz / black mat
25/2331.22

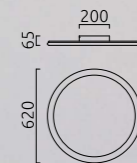

SAO

LED   IP20 

Acryldiffusor satiniert
mit Spiegel Ø 330 mm
acrylic diffuser satinised
with mirror Ø 330 mm

40 W, 2700 K, B 4470 / N 3710 lm, CRI > 90

mattweiß / white mat
28/2330.07-50

blattgold / gold leaf
28/2330.09-50

mattschwarz / black mat
28/2330.22-50





HELEN

LED   IP20 

Acryldiffusor satiniert
acrylic diffuser satinised

32 W, 2700 K, B 3440 / N 1610 lm, CRI > 90

mattweiß / white mat

Reflektor / reflector

18/2410.07-07 weiß / white
18/2410.07-09 blattgold / gold leaf
18/2410.07-50 Spiegel / mirror Ø 405 mm

mattschwarz / black mat

Reflektor / reflector

18/2410.22-07 weiß / white
18/2410.22-09 blattgold / gold leaf
18/2410.22-50 Spiegel / mirror Ø 405 mm

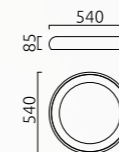



SONA

LED   IP20

Acryldiffusor satiniert
acrylic diffuser satinised



24 W, 2900 K, B 2900 / N 2040 lm, CRI > 85

mattschwarz / black mat
15/1993.22

mattweiß / white mat
15/1993.07

blattgold / gold leaf
15/1993.09



60 W, 2900 K, B 6700 / N 4690 lm, CRI > 85

mattschwarz / black mat
25/1994.22

mattweiß / white mat
25/1994.07

blattgold / gold leaf
25/1994.09

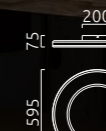



COSI

LED  IP30

Glas satiniert - Kanten poliert
glass satinised - edges polished



7 W, 2900 K, B 1070 / N 610 lm, CRI > 90

chrom / chrome

15/1905.04

mattnickel / nickel mat

15/1905.06

mattschwarz / black mat

15/1905.22



12 W, 2900 K, B 1780 / N 1020 lm, CRI > 90

chrom / chrome

15/1906.04

mattnickel / nickel mat

15/1906.06

mattschwarz / black mat

15/1906.22



26 W, 2900 K, B 3220 / N 1840 lm, CRI > 90

chrom / chrome

15/1907.04

mattnickel / nickel mat

15/1907.06

mattschwarz / black mat

15/1907.22

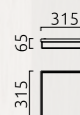



VIRTO



prismatischer Diffusor < 19
Lichtverteilung 85 % direkt - 15 % indirekt
prismatic diffuser UGR < 19
light distribution 85 % direct - 15 % indirect

50 W, 3000 K, B 5850 / N 2870 lm, CRI > 85

mattweiß / white mat
15/2416.07
15/2416.07-DALI

mattschwarz / black mat
15/2416.22
15/2416.22-DALI

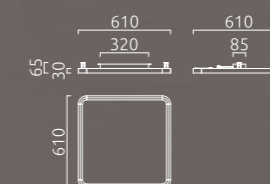

Deckengehäuse flexibel hinter oder neben der
Leuchte montierbar
housing can be mounted flexibly behind or next to
the luminaire



VIRTO



prismatischer Diffusor <math>< 19</math>
Lichtverteilung 85 % direkt - 15 % indirekt
prismatic diffuser UGR <math>< 19</math>
light distribution 85 % direct - 15 % indirect

50 W, 3000 K, B 5850 / N 2870 lm, CRI > 85



Deckengehäuse flexibel hinter oder neben der Leuchte montierbar
housing can be mounted flexibly behind or next to the luminaire

mattweiß / white mat

15/2417.07

15/2417.07-DALI

mattschwarz / black mat

15/2417.22

15/2417.22-DALI

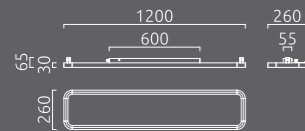



RACK

LED  IP20

Acryldiffusor satiniert
acrylic diffuser satinised

22 W, 2900 K, B 2460 / N 1730 lm, CRI > 90

mattweiß / white mat
15/2254.07

blattgold / gold leaf
15/2254.09

mattschwarz / black mat
15/2254.22

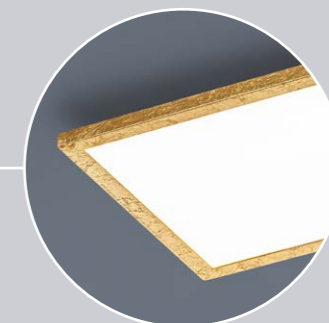
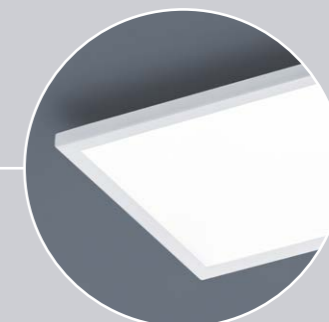
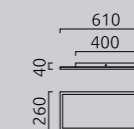

RACK



Acryldiffusor satiniert
acrylic diffuser satinised

21 W, 2900 K, B 2550 / N 1800 lm, CRI > 90



mattweiß / white mat
15/1954.07

blattgold / gold leaf
15/1954.09

mattschwarz / black mat
15/1954.22

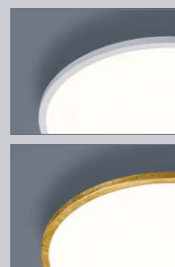
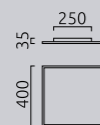

mattweiß / white mat
15/1956.07

blattgold / gold leaf
15/1956.09

mattschwarz / black mat
15/1956.22





LICA

LED  IP20 

mattschwarz
Acryldiffusor satiniert
Lichtverteilung direkt / indirekt
Abstrahlwinkel 120°

black mat
acrylic diffuser satinised
light distribution direct / indirect
beam angle 120°



30 W, B 3280 / N 2590/2680/2740 lm, CRI > 90
15/2210.22

50 W, B 5480 / N 4190/4510/4790 lm, CRI > 90
15/2211.22

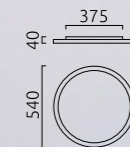
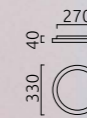

cct 2700 / 3500 / 4000 K
fix einstellbar an der Leuchte oder
variabel über Wandschalter (BS)
constantly adjustable on luminaire or
variable by wall switch (BS)



TAMO

LED IP54 YL Plus

Deckeneinbauleuchte
Acryldiffusor satiniert
Abstrahlwinkel 120°
recessed mounted luminaire
acrylic diffuser satinised
beam angle 120°

max. B 1940 / N 1650 lm, CRI > 85



mattweiß / white mat
15/2301.07

mattschwarz / black mat
15/2301.22

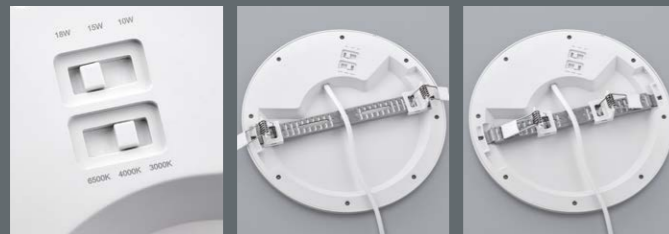

18 W / 15 W / 10 W
3000 K / 4000K / 6500 K
An Deckenausschnitt variabel anpassbar 65 - 205 mm
adjustable to cut-out 65 - 205 mm
einstellbar an der
Leuchte
adjustable
on luminaire





TANA

LED IP44

mattschwarz
Glas teilsatiniert
black mat
glass partially satinised



18 W, 2900 K, B 2220 / N 870 lm, CRI > 90
15/1933.22



22 W, 2900 K, B 2640 / N 1050 lm, CRI > 90
15/1934.22





7 W, 2700 K, B 795 / N 480 lm, CRI > 80

weiß / white
15/2409.07

schwarz / black
15/2409.22



28 W, 2700 K, B 3180 / N 1910 lm, CRI > 80

weiß / white
45/2309.07

schwarz / black
45/2309.22



40 W, 2700 K, B 4630 / N 2780 lm, CRI > 80

weiß / white
65/2309.07

schwarz / black
65/2309.22



28 W, 2700 K, B 3180 / N 1910 lm, CRI > 80

weiß / white
45/2319.07

schwarz / black
45/2319.22



BELOS



Muranoglas
Murano glass



www.helestra.de/belos

SIMO



Acrylglas teilsatiniert
acrylic glass partially satinised



25 W, 2700 K, B 2690 / N 1850 lm, CRI > 90

mattweiß / white mat
75/2212.07

mattschwarz / black mat
75/2212.22

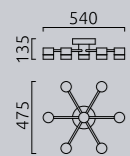

40 W, 2700 K, B 4360 / N 3350 lm, CRI > 90

mattweiß / white mat
115/2212.07

mattschwarz / black mat
115/2212.22

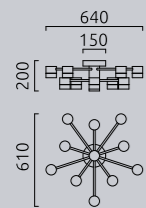



CANIO

E27 IP30

mattweiß
Innenglas opal weiß
white mat
inside glass opal white

1 x E27



Glas klar / glass clear
15/1735.07/5239

Glas grau / glass grey
15/1735.07/5240

Glas amber / glass amber
15/1735.07/5241



TAIL

LED  IP54



13 W, 2700 K, B 1480 / N 530 lm, CRI > 90

mattweiß / white mat

28/2114.07

mattschwarz - gold / black mat - gold

28/2114.28

55 200
 





DEX

LED   IP20

aluminium poliert - mattweiß
drehbar
aluminum polished - white mat
rotatable

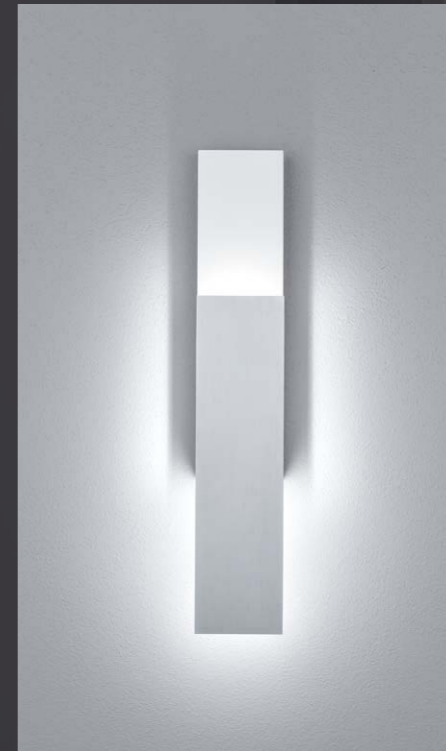

13 W, 3000 K, B 1480 / N 890 lm, CRI > 90
18/2035.25

270 80
70 H
80 H





DAYO

LED IP20 YL Plus

Glas satiniert
schwenkbar
glass satinised
tiltable

7 W, 2700 K, B 940 / N 660 lm, CRI > 80

<u>mattweiß / white mat</u>	144	112
18/2308.07	48	0
<u>mattschwarz / black mat</u>	112	0
18/2308.22		



COR



LED  IP20

Glas schwarz - klar
Abstrahlwinkel horizontal 136°, vertikal 74°
glass black - clear
beam angle horizontal 136°, vertical 74°

22 W, 2700 K, B 2450 / N 1370 lm, CRI > 90



mattweiß / white mat
18/2116.07

40  
160 



ADEO

LED  IP20

8 W, 2800 K, B 740 / N 490 lm, CRI > 90

mattnickel / nickel mat
18/1807.06

mattweiß / white mat
18/1807.07

200 65



YONA

LED IP20



15 W, 3000 K, B 1650 / N 1310 lm, CRI > 90

18 W, 3000 K, B 1980 / N 1430 lm, CRI > 90

mattweiß / white mat
28/1427.07

aluminium poliert - mattweiß
aluminium polished - white mat
28/1427.25

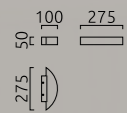

mattweiß / white mat
38/1427.07

aluminium poliert - mattweiß
aluminium polished - white mat
38/1427.25

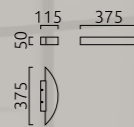

FOSCA

LED IP20



9 W, 3000 K, B 960 / N 580 lm, CRI > 90

mattweiß / white mat
18/1328.07

aluminium matt / aluminium mat
18/1328.26

60 145 160
C
H





PONT

IP20

6,5 W, 2900 K, B 580 / N 540 lm, CRI > 90



Gips weiß / gypsum white
18/1947.07

115 60 155
□ ○



SIRI

G9 IP20

1 x G9



mattweiß
white mat
18/1175.07

aluminium matt
aluminium mat
18/1175.26

100 100
□ □

Optionales Zubehör:
Optional Accessories:



Streuscheibe aluminium matt, Glas satiniert
diffuser aluminium mat, glass satinised
5017

Streuscheibe matt weiß, Glas satiniert
diffuser white mat, glass satinised
5056



Metallscheibe aluminium matt (Schlitz)
slotted metal plate aluminium mat
5019

Metallscheibe matt weiß (Schlitz)
slotted metal plate white mat
5057

Leuchtmittel nicht im Lieferumfang
bulb not included



www.helestra.de/siri

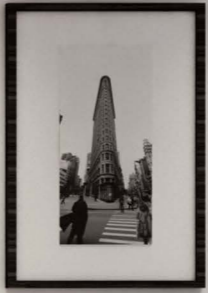

SIRI LED

LED IP30

18 W, 3000 K, B 1860 / N 1340 lm, CRI > 90



mit satiniertes Diffusorscheibe / with satinised diffuser

mattweiß / white mat
15/1558.07

100
100
100



DORA

LED IP20

Glas satiniert
glass satiniert

7,5 W, 2900 K, B 880 / N 510 lm, CRI > 85

mattweiß / white mat

15/1804.07

mattschwarz / black mat

15/1804.22

100
85
100

7,5 W, 2900 K, B 880 / N 540 lm, CRI > 85

mattweiß / white mat

15/1805.07

mattschwarz / black mat

15/1805.22

100
85
100



KARI

LED  IP30

12 W, 2700 K, B 1180 / N 1030 lm, CRI > 90

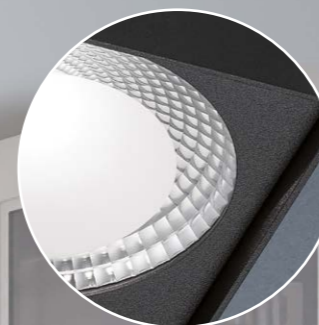

mattschwarz / black mat
15/1945.22

mattnickel / nickel mat
15/1945.06

mattweiß / white mat
15/1945.07

120
70
120

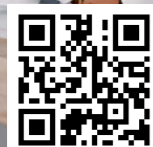



KARI

LED  IP30

12 W, 2700 K, B 1180 / N 1030 lm, CRI > 90



mattschwarz / black mat
15/1946.22

mattnickel / nickel mat
15/1946.06

mattweiß / white mat
15/1946.07

115
75
115



www.helestra.de/kari

ENIO



Acryldiffusor satiniert
acrylic diffuser satinised



12 W, 2700 K, B 1310 / N 940 lm, CRI > 90

mattweiß / white mat

	Reflektor / reflector
15/2215.07-07	weiß / white
15/2215.07-09	gold / gold
15/2215.07-22	schwarz / black

mattschwarz / black mat

	Reflektor / reflector
15/2215.22-07	weiß / white
15/2215.22-09	gold / gold
15/2215.22-22	schwarz / black



16 W, 2700 K, B 1670 / N 1390 lm, CRI > 90

mattweiß / white mat

	Reflektor / reflector
15/2216.07-07	weiß / white
15/2216.07-09	gold / gold
15/2216.07-22	schwarz / black

mattschwarz / black mat

	Reflektor / reflector
15/2216.22-07	weiß / white
15/2216.22-09	gold / gold
15/2216.22-22	schwarz / black



28 W, 2700 K, B 2990 / N 2460 lm, CRI > 90

mattweiß / white mat

	Reflektor / reflector
15/2415.07-07	weiß / white
15/2415.07-09	gold / gold
15/2415.07-22	schwarz / black

mattschwarz / black mat

	Reflektor / reflector
15/2415.22-07	weiß / white
15/2415.22-09	gold / gold
15/2415.22-22	schwarz / black

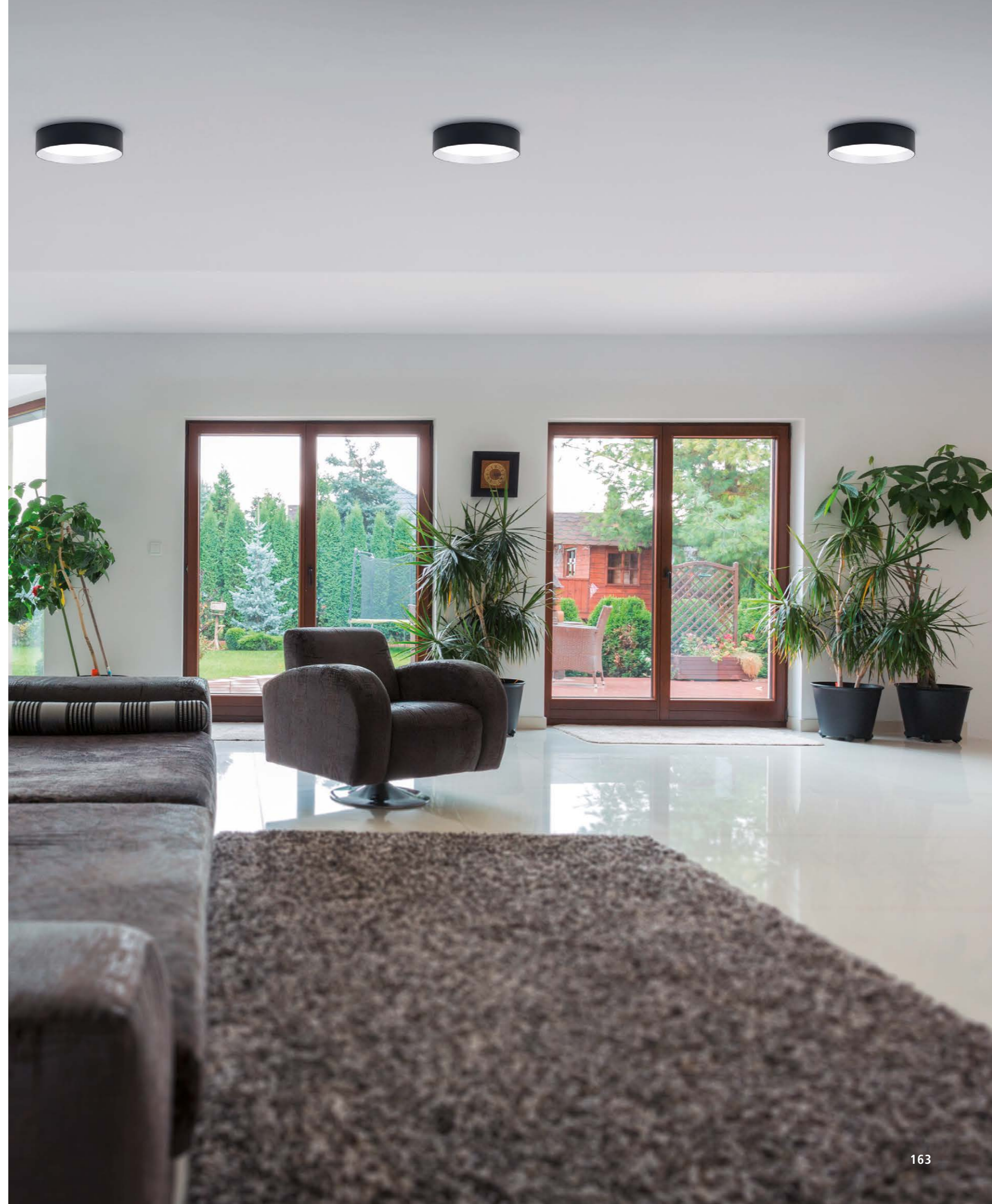
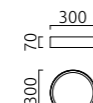



INEO

LED  IP20  YL Plus 

230 V - 8 W, 2700 K, B 720 / N 650 lm, CRI > 90

100 
80 
100 

mattweiß / white mat

Reflektor / reflector

15/2303.07-07 weiß / white

15/2303.07-09 gold / gold

15/2303.07-22 schwarz / black



mattschwarz / black mat

Reflektor / reflector

15/2303.22-07 weiß / white

15/2303.22-09 gold / gold

15/2303.22-22 schwarz / black





RIWA

LED   IP20

Abstrahlwinkel 30°
dreh- und schwenkbar
beam angle 30°
rotatable and tiltable



8 W, 2700 K, B 820 / N 480 lm, CRI > 90

mattweiß / white mat
15/1806.07

mattschwarz / black mat
15/1806.07

120
50 20
Ø 176



24 W, 2700 K, B 2460 / N 1440 lm, CRI > 90

mattweiß / white mat
35/1806.07

mattschwarz / black mat
35/1806.22

120
65
390
Ø 176



GOTO

LED  IP54

Glaslinse klar
dreh- und kipubar
glass lens clear
rotatable and tiltable

8,5 W, 2700 K, B 780 / N 570 lm, CRI > 90



mattweiß / white mat
15/2013.07

mattschwarz / black mat
15/2013.22

70 
120 

85 







PAX

mattweiß
Glas klar
dreh- und schwenkbar
Abstrahlwinkel 12°
white mat
glass clear
rotatable and tiltable
beam angle 12°



230 V - 7,5 W, 2900 K, B 780 / N 560 lm, CRI > 90
15/1808.07



230 V - 15 W, 2900 K, B 1560 / N 1120 lm, CRI > 90
25/1808.07

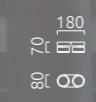



PONT

LED  IP20

Glaslinse klar mit herausnehmbarer matter Filterscheibe
dreh- (355°) und kippar (80°)
Abstrahlwinkel verstellbar 15°-45°
glass lens clear with removable mat diffuser
rotatable (355°) and tiltable (80°)
beam angle adjustable 15°-45°



19 W, 2700 K, B 1960 / N 1140 lm, CRI > 90

mattweiß / white mat

25/2080.07

mattschwarz / black mat

25/2080.22

250
170
85
Ø=Ø



ROTA

LED  IP20  YL Plus 

dreh- und schwenkbar
rotatable and tiltable



9 W, 2800 K, B 890 / N 620 lm, CRI > 95, 36°
mattweiß / white mat
15/2164.07
mattschwarz / black mat
15/2164.22



15 W, 2800 K, B 1580 / N 1170 lm, CRI > 95, 40°
mattweiß / white mat
15/1964.07
mattschwarz / black mat
15/1964.22



30 W, 2800 K, B 3160 / N 2340 lm, CRI > 95, 40°
mattweiß / white mat
25/1964.07
mattschwarz / black mat
25/1964.22

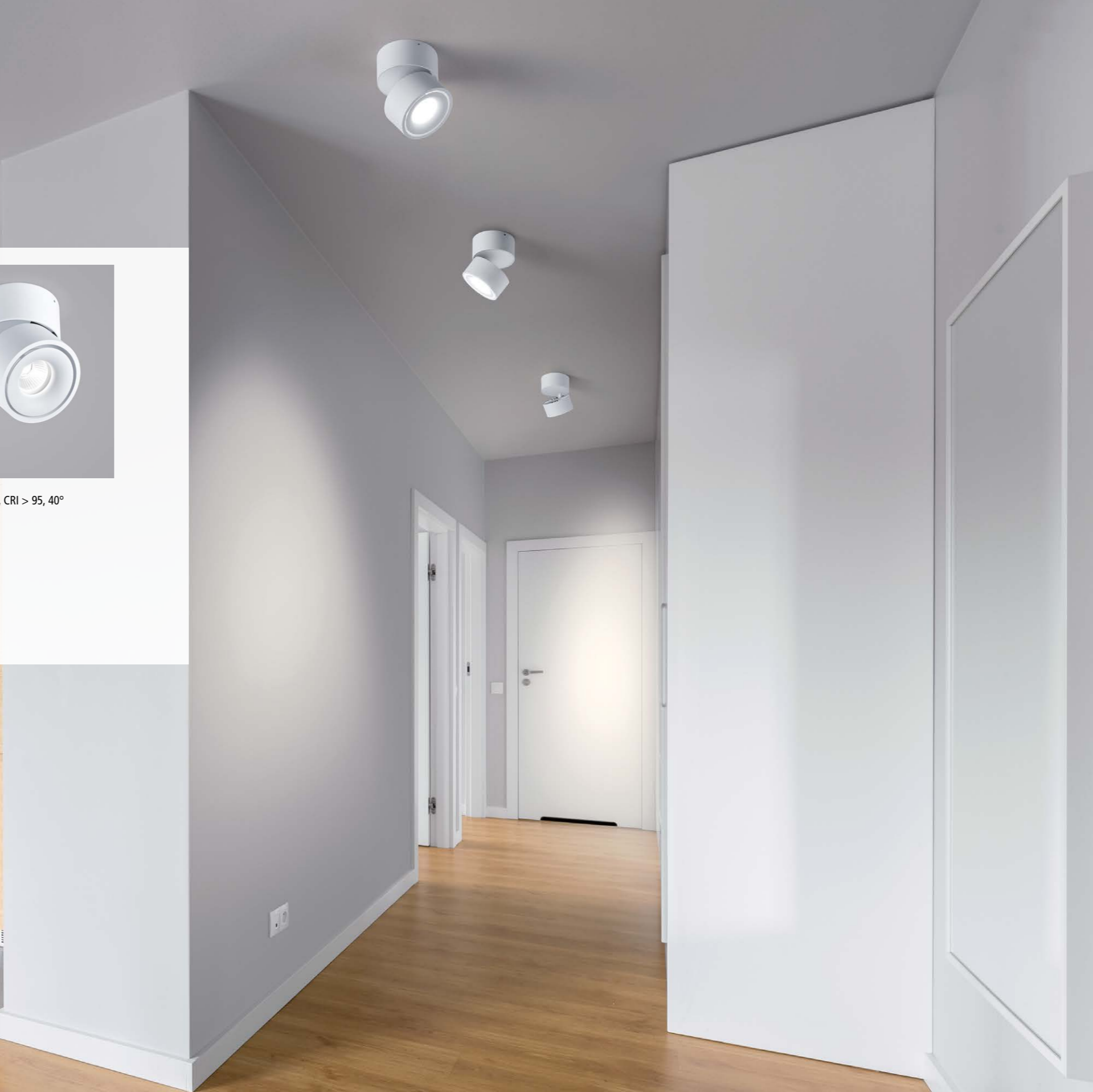

NOG

GU10 IP65 YL Plus



GU10-LED max. Länge / length 58 mm

mattweiß / white mat

15/2129.07

mattschwarz / black mat

15/2129.22

80
80 □
80 ©

Leuchtmittel nicht im Lieferumfang
bulb not included





TUDO

GU10 IP20 **YL**
Plus

ca. 30° schwenkbar
approx. 30° tiltable

GU10-LED max. Länge / length 58 mm



mattweiß / white mat
15/2329.07

mattschwarz / black mat
15/2329.22

85

100

Leuchtmittel nicht im Lieferumfang
bulb not included



TUDO

GU10 IP20 YL Plus

ca. 30° schwenkbar
approx. 30° tiltable

1 x GU10-LED



mattweiß / white mat

15/2429.07

VPE 4 Stück

15/2429.07-4

mattschwarz / black mat

15/2429.22

VPE 4 Stück

15/2429.22-4

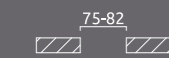

Leuchtmittel nicht im Lieferumfang
bulb not included





SKA

LED   IP20

Einbauleuchte
Glas teilsatiniert
recessed luminaire
glass partially satinised

10 W, 2700 K, B 1060 / N 510 lm, CRI > 90



15/2012.00

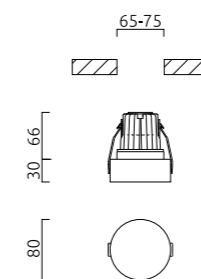

ONTO

LED IP20

Einbauleuchte
Lichtaustritt verstellbar
recessed luminaire
light beam adjustable

4 W, 2900 K, B 420 / N 310 lm, CRI > 90
indirekt / uplight



Zum Einbau in Unterputz- Hohlwandboxen
installation in plaster- or cavity wall box



mattweiß / white mat
15/1938.07

aluminium matt / aluminium mat
15/1938.26

62,15 80

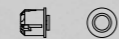

SENT

LED IP54

mattweiß
Einbauleuchte
Lichtaustritt verstellbar
white mat
recessed luminaire
light beam adjustable

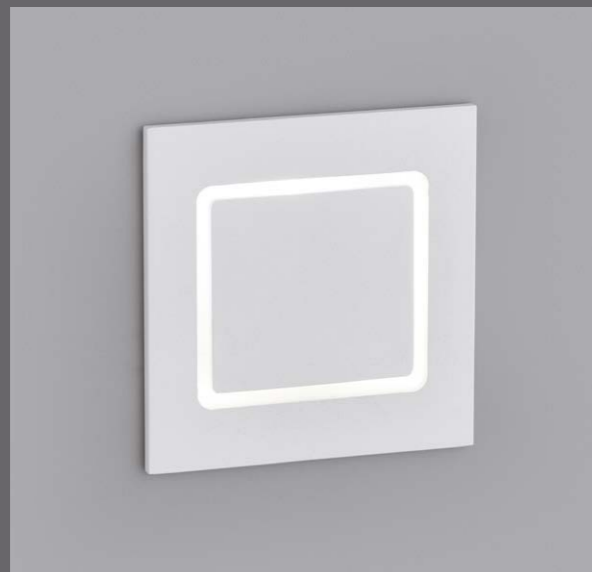

3 W, 3000 K, B 350 / N 170 lm, CRI > 90
18/2016.07

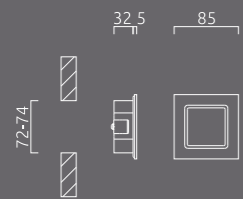

ITO

LED IP20 YL Plus

Einbauleuchte
zum Einbau in Unterputz- / Hohlwanddose
recessed luminaire
installation in plaster- or cavity wall box

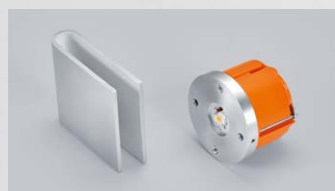

9,7 W, 2700 K, B 980 / N 120 lm, CRI > 85

mattweiß / white mat

18/2411.07

aluminium matt / aluminium mat

18/2411.25











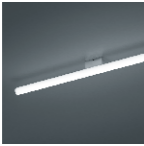

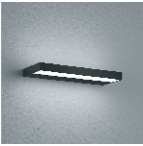
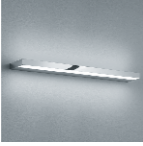



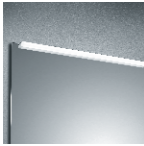

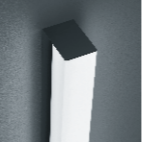

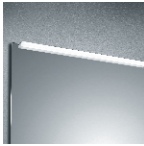

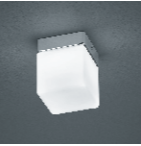







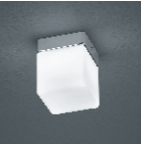

62 35,5 85
E14 E27



BATHROOM



NEW

ISOU 194-195	LOOM 196-199	SLATE 200-203	VIS 204-205	THEIA 206-209	NOK 210-211	LADO 212-213	LADO-S 214-215
	 	 		 		 	
ONTA 216-217	PONTO 218-219	GAIA 220-223	ARGO 224-225	COSI 226-231	ZELO 232-235	KYMO 236-237	KETO 238-239
	 	 		  	 		 
LIS 240-241	OLVI 242-243	TANA 244-245	PALA 246-247	OSO 248-249	IVA 250-251	SID 252-253	
 		 		 			

INDEX

ARGO	224-225
COSI	226-231
GAIA	220-223
ISOU	194-195
IVA	250-251
KETO	238-239
KYMO	236-237
LADO	212-213
LADO-S	214-215
LIS	240-241
LOOM	196-199
NOK	210-211
OLVI	242-243
ONTA	216-217
OSO	248-249
PALA	246-247
PONTO	218-219
SID	252-253
SLATE	200-203
TANA	244-245
THEIA	206-209
VIS	204-205
ZELO	232-235



ISOU

LED IP44 **YL**
Plus

Acryldiffusor innen opal / außen klar
Farbtemperatur einstellbar 3000 oder 4000 K
acrylic diffuser opal inside / clear outside
colour temperature adjustable 3000 or 4000 K

12 W, B 1800 / N 1210 lm, CRI > 90

chrom / chrome
18/2420.04

mattschwarz / black mat
18/2420.22

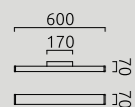

18 W, B 2500 / N 1620 lm, CRI > 90

chrom / chrome
18/2421.04

mattschwarz / black mat
18/2421.22

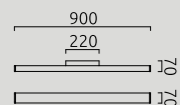

24 W, B 2900 / N 1890 lm, CRI > 90

chrom / chrome
18/2422.04

mattschwarz / black mat
18/2422.22

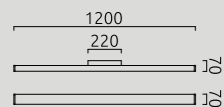

LOOM

LED IP44

chrom
Acrylglas satiniert
chrome
acrylic glass satinised



5,5 W, 2900 K, B 625 / N 500 lm, CRI > 90
18/2020.04



12 W, 2900 K, B 1500 / N 1130 lm, CRI > 90
18/2021.04



18 W, 2900 K, B 2250 / N 1710 lm, CRI > 90
18/2022.04



20 W, 2900 K, B 2750 / N 1990 lm, CRI > 90
18/2023.04



LOOM

LED IP44

mattschwarz
Acrylglas satiniert
black mat
acrylic glass satinised



5,5 W, 2900 K, B 625 / N 500 lm, CRI > 90
18/2020.22

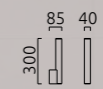

12 W, 2900 K, B 1500 / N 1130 lm, CRI > 90
18/2021.22

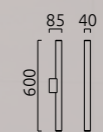

18 W, 2900 K, B 2250 / N 1710 lm, CRI > 90
18/2022.22



20 W, 2900 K, B 2750 / N 1990 lm, CRI > 90
18/2023.22

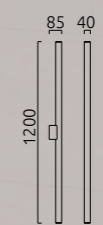

SLATE

LED IP44

mattschwarz
Acrylglas satiniert
black mat
acrylic glass satinised



6,5 W, 2900 K, B 710 / N 360 lm, CRI > 90
18/2037.22



15 W, 2900 K, B 1570 / N 960 lm, CRI > 90
18/2038.22

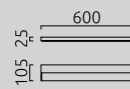

20 W, 2900 K, B 2130 / N 1260 lm, CRI > 90
18/2039.22

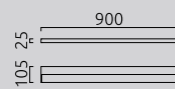

29 W, 2900 K, B 3120 / N 1740 lm, CRI > 90
18/2040.22

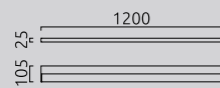

SLATE

LED IP44

chrom
Acrylglas satiniert
chrome
acrylic glass satinised



6,5 W, 2900 K, B 710 / N 360 lm, CRI > 90
18/2037.04



15 W, 2900 K, B 1570 / N 960 lm, CRI > 90
18/2038.04

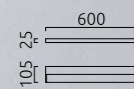

20 W, 2900 K, B 2130 / N 1260 lm, CRI > 90
18/2039.04

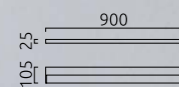

29 W, 2900 K, B 3120 / N 1740 lm, CRI > 90
18/2040.04

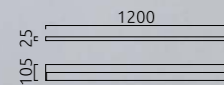

VIS

LED IP44

chrom
Acrylglas satiniert
chrome
acrylic glass satinised



23 W, 2900 K, B 2490 / N 1540 lm, CRI > 90
18/2024.04

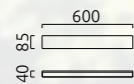

34 W, 2900 K, B 3680 / N 2260 lm, CRI > 90
18/2025.04

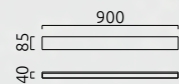

46 W, 2900 K, B 5040 / N 3090 lm, CRI > 90
18/2026.04

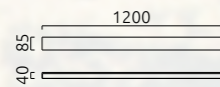

inkl. Zubehör für Wand- oder Spiegelmontage
incl. accessories for wall or mirror mounting



THEIA

LED IP44

mattschwarz
Glas satiniert
Acrylglas satiniert
black matt
glass satinised
acrylic glass satinised



13 W, 2900 K, B 1380 / N 495 lm, CRI > 90
18/1825.22



19 W, 2900 K, B 2110 / N 980 lm, CRI > 90
18/1826.22



25 W, 2900 K, B 2820 / N 1410 lm, CRI > 90
18/1827.22



31 W, 2900 K, B 3540 / N 1800 lm, CRI > 90
18/1828.22



THEIA

LED IP44

chrom
Glas satiniert
Acrylglas satiniert
chrome
glass satinised
acrylic glass satinised



13 W, 2900 K, B 1380 / N 495 lm, CRI > 90
18/1825.04

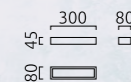

19 W, 2900 K, B 2110 / N 980 lm, CRI > 90
18/1826.04

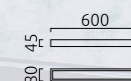

25 W, 2900 K, B 2820 / N 1410 lm, CRI > 90
18/1827.04

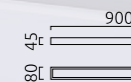

31 W, 2900 K, B 3540 / N 1800 lm, CRI > 90
18/1828.04

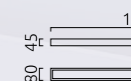

NOK

LED IP44

chrom
Acrylglas satiniert
chrome
acrylic glass satinised

inkl. Zubehör für Wand- oder Spiegelmontage
incl. accessories for wall or mirror mounting



16 W, 2900 K, B 1730 / N 1250 lm, CRI > 90
18/2031.04

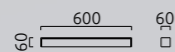

25 W, 2900 K, B 2720 / N 2050 lm, CRI > 90
18/2032.04

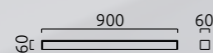

32 W, 2900 K, B 3460 / N 2590 lm, CRI > 90
18/2033.04

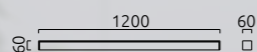

LADO

LED IP44

Acrylglas satiniert
acrylic glass satinised



12 W, 2900 K, B 1260 / N 1040 lm,
CRI > 90

chrom / chrome
18/1812.04

mattschwarz / black mat
18/1812.22

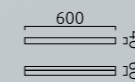

18 W, 2900 K, B 1890 / N 1560 lm,
CRI > 90

chrom / chrome
18/1813.04

mattschwarz / black mat
18/1813.22

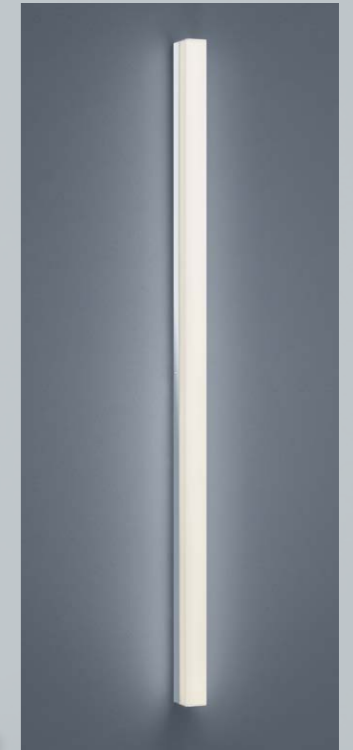
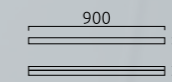

24 W, 2900 K, B 2520 / N 2080 lm,
CRI > 90

chrom / chrome
18/1814.04

mattschwarz / black mat
18/1814.22

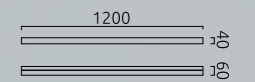

inkl. Zubehör für Wand- oder
Spiegelmontage
incl. accessories for wall or
mirror mounting



www.helestra.de/lado

LADO-S

LED IP44

Acrylglas satiniert
acrylic glass satinised

12 W, B 1260 / N 1040 lm, CRI > 90

chrom / chrome

18/2423.04

mattschwarz / black mat

18/2423.22

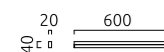

18 W, B 1890 / N 1560 lm, CRI > 90

chrom / chrome

18/2424.04

mattschwarz / black mat

18/2424.22

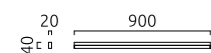

24 W, B 2520 / N 2080 lm, CRI > 90

chrom / chrome

18/2425.04

mattschwarz / black mat

18/2425.22

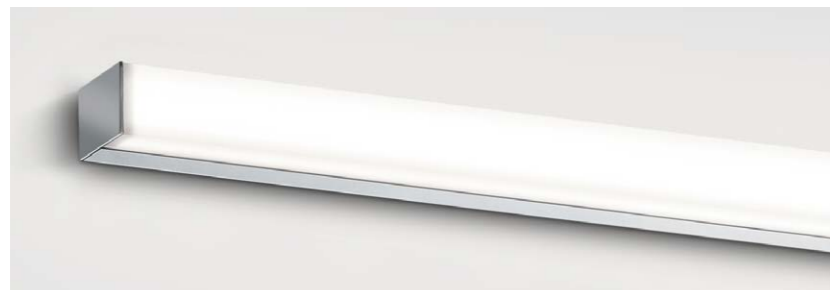
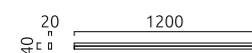

inkl. Zubehör für Wand- oder
Spiegelmontage
incl. accessories for wall or
mirror mounting



ONTA

LED IP44

chrom
Acrylglas satiniert
nur zur Spiegelmontage
chrome
acrylic glass satinised
mirror mounting only



13 W, 2900 K, B 1290 / N 950 lm, CRI > 90
18/2120.04



18 W, 2900 K, B 1890 / N 1430 lm, CRI > 90
18/2121.04



24 W, 2900 K, B 2540 / N 1850 lm, CRI > 90
18/2122.04



PONTO

LED IP44

Acrylglas satiniert
acrylic glass satinised

12 W, 2900 K, B 1280 / N 980 lm, CRI > 90

chrom / chrome

18/1833.04

mattschwarz / black mat

18/1833.22

70 600
D

18 W, 2900 K, B 1920 / N 1460 lm, CRI > 90

chrom / chrome

18/1834.04

mattschwarz / black mat

18/1834.22

70 900
D

24 W, 2900 K, B 2560 / N 1940 lm, CRI > 90

chrom / chrome

18/1835.04

mattschwarz / black mat

18/1835.22

70 1200
D



GAIA

LED   IP44

chrom
Acrylglas satiniert
inkl. LED-Konverter extern (130x52x13 mm)
Tuneable white 2700 K - 6000 K

chrome
acrylic glass satinised
incl. LED-converter external (130x52x13 mm)
Tuneable white 2700 K - 6000 K



12 W, 2700-6000 K, B 1080 / N 650 lm, CRI > 90
18/1815.04



16 W, 2700-6000 K, B 1520 / N 830 lm, CRI > 90
18/1816.04



18 W, 2700-6000 K, B 1760 / N 1070 lm, CRI > 90
18/1817.04



inkl. Zubehör für Wand-, Spiegel- oder Möbelmontage
incl. accessories for wall, mirror or surface mounting



GAIA

LED   IP44

chrom
Acrylglas satiniert
inkl. LED-Konverter extern (130x52x13 mm)
Tuneable white 2700 K - 6000 K

chrome
acrylic glass satinised
incl. LED-converter external (130x52x13 mm)
Tuneable white 2700 K - 6000 K



12 W, 2700-6000 K, B 1080 / N 650 lm, CRI > 90
18/1815.04



16 W, 2700-6000 K, B 1520 / N 830 lm, CRI > 90
18/1816.04

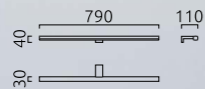

18 W, 2700-6000 K, B 1760 / N 1070 lm, CRI > 90
18/1817.04

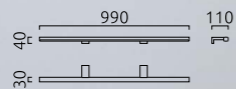

inkl. Zubehör für Wand-, Spiegel- oder Möbelmontage
incl. accessories for wall, mirror or surface mounting



ARGO

LED IP44

chrom
Acrylglas satiniert
chrome
acrylic glass satinised

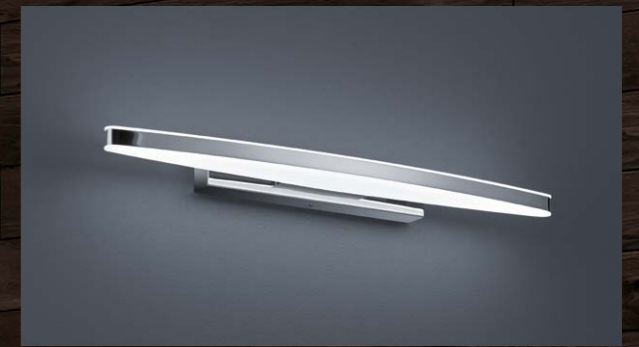

10 W, 2900 K, B 980 / N 660 lm, CRI > 90
18/1935.04

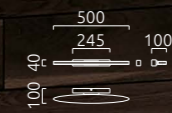

12 W, 2900 K, B 1270 / N 850 lm, CRI > 90
18/1936.04



COSI

LED  IP30

Glas satiniert - Kanten poliert
glass satinised - edges polished



10 W, 2900 K, B 1150 / N 660 lm,
CRI > 90

chrom / chrome
18/2005.04

mattnickel / nickel mat
18/2005.06

mattschwarz / black mat
18/2005.22



20 W, 2900 K, B 2660 / N1520 lm,
CRI > 90

chrom / chrome
18/2006.04

mattnickel / nickel mat
18/2006.06

mattschwarz / black mat
18/2006.22





COSI

LED  IP30

Glas satiniert - Kanten poliert
glass satinised - edges polished



7 W, 2900 K, B 1070 / N 610 lm, CRI > 90 

chrom / chrome
15/1905.04

mattnickel / nickel mat
15/1905.06

mattschwarz / black mat
15/1905.22

12 W, 2900 K, B 1780 / N 1020 lm, CRI > 90 

chrom / chrome
15/1906.04

mattnickel / nickel mat
15/1906.06

mattschwarz / black mat
15/1906.22

26 W, 2900 K, B 3220 / N 1840 lm, CRI > 90 

chrom / chrome
15/1907.04

mattnickel / nickel mat
15/1907.06

mattschwarz / black mat
15/1907.22



COSI

LED IP30

Glas satiniert - Kanten poliert
glass satinised - edges polished

22 W, 2900 K, B 2490 / N 1420 lm, CRI > 90



mattnickel / nickel mat
15/2105.06

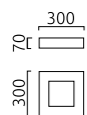

chrom / chrome
15/2105.04



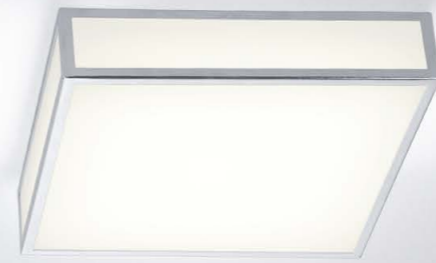

ZELO

LED IP44

chrom
Acrylglas satiniert
chrome
acrylic glass satinised



12 W, 2900 K, B 1320 / N 820 lm, CRI > 90
15/1950.04



19 W, 2900 K, B 2180 / N 1310 lm, CRI > 90
15/1951.04





ZELO

LED IP44

chrom
Opalglas satiniert
chrome
opal glass satinised



12 W, 2900 K, B 1460 / N 940 lm, CRI > 90
15/1820.04



18 W, 2900 K, B 2210 / N 1420 lm, CRI > 90
15/1821.04



KYMO

LED IP44

chrom
Glas opal weiß
chrome
glass opal white



12 W, 2900 K, B 1360 / N 940 lm, CRI > 90
15/2124.04



21 W, 2900 K, B 2040 / N 1420 lm, CRI > 90
15/2125.04

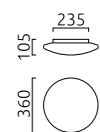

KETO

LED IP44

Opalglas satiniert
opal glass satinised

6 W, 2900 K, B 630 / N 410 lm, CRI > 90



chrom / chrome
15/1822.04

mattschwarz / black mat
15/1822.22

100
125
100



chrom / chrome
15/1823.04

mattschwarz / black mat
15/1823.22

100
125
100





LIS

LED IP44

chrom
Opalglas satiniert
chrome
glass opal satinised



3,5 W, 2900 K, B 490 / N 340 lm, CRI > 90
18/2123.04

140 120

12 W, 2900 K, B 1680 / N 1010 lm, CRI > 90
48/2029.04

120 600



OLVI

LED IP44

chrom
Innenglas Opal weiß
Aussenglas klar
chrome
Internal glass opal white
external glass clear



12 W, 2900 K, B 1320 / N 840 lm, CRI > 90
15/1930.04



12 W, 2900 K, B 1320 / N 1020 lm, CRI > 90
15/1931.04



TANA

LED IP44

Glas teilsatiniert
glass partially satinised



18 W, 2900 K, B 2220 / N 870 lm, CRI > 90

chrom / chrome

15/1933.04

mattschwarz / black mat

15/1933.22



22 W, 2900 K, B 2640 / N 1050 lm, CRI > 90

chrom / chrome

15/1934.04

mattschwarz / black mat

15/1934.22





PALA

LED  IP30

Acryldiffusor satiniert
acrylic diffuser satinised

9 W, 2900 K, B 900 / N 725 lm, CRI > 90

mattweiß / white mat
15/1629.07

mattschwarz / black mat
15/1629.22

100 
70 
100 



OSO

LED  IP44

Abstrahlwinkel 40°
beam angle 40°

7,5 W, 2700 K, B 710 / N 370 lm, CRI > 90



Glas klar - opal / glass clear - opal
mattweiß / white mat
15/1553.07
aluminium matt / aluminium mat
15/1553.26

Glas klar-schwarz / glass clear-black
mattschwarz / black mat
15/1553.22



Glas klar - opal / glass clear - opal
mattweiß / white mat
15/1552.07
aluminium matt / aluminium mat
15/1552.26

Glas klar-schwarz / glass clear-black
mattschwarz / black mat
15/1552.22



IVA

LED   IP44

Acrylring satiniert
acrylic ring satinised

5 W, 2900 K, B 560 / N 480 lm, CRI > 90



15/2041.00

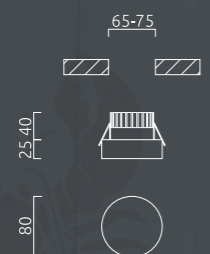



SID

LED   IP65

schwenkbar 20°
Abstrahlwinkel 60°
tiltable 20°
beam angle 60°

11 W, 3000 K, B 1150 / N 890 lm, CRI > 90



chrom / chrome
15/2034.04

mattweiß / white mat
15/2034.07

mattschwarz / black mat
15/2034.22

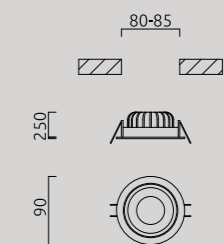



add-it

Das modulare Schienensystem
mit unzähligen Möglichkeiten.

The modular track system with
countless possibilities.

Add-it Schienensystem

Mit unserem modularen Schienensystem bringen wir Licht ins Dunkel! Dekorativ – innovativ – intuitiv!

Dekoratives Licht lässt sich mit dem Add-it System individuell an fast jede Situation anpassen. Eine große Auswahl an Strahlern, Pendelleuchten und Lichtelementen, sowie vielfältige Konfigurationsmöglichkeiten machen es möglich.

Innovative Technik ermöglicht die einfache Installation als reines Aufbausystem (Treiber in der Schiene integriert) und die Dimmung über Funk. Auch eine App-Steuerung ist möglich.

Add-it track system

With our modular track system, we bring light into the dark! Decorative – innovative – intuitive!

Decorative light is easy to adapt to almost any situation with the Add-it system. A great choice of spots, pendant luminaires and light elements as well as numerous configuration options make it possible.

Innovative technology allows for surface-only installation (driver integrated in the track) and wireless dimming, dramatically simplifying the installation. Optional app control is also available.

Bei der Planung hilft Ihnen auch unser Konfigurator auf unserer Website:

Our configurator on our website will also help you with planning:

www.helestra.de/add-it

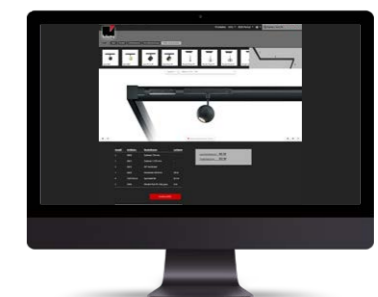

ADD-IT

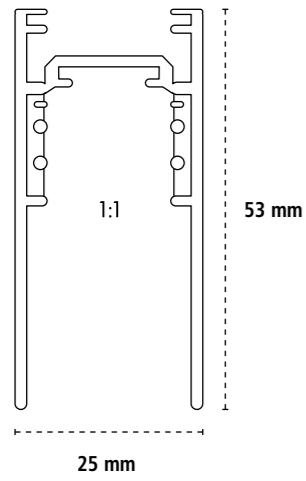

- 750 mm
mattweiß / white mat
mattschwarz / black mat
- 1150 mm
mattweiß / white mat
mattschwarz / black mat
- 1650 mm
mattweiß / white mat
mattschwarz / black mat

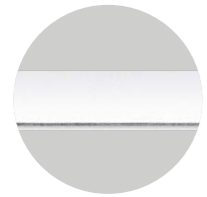

Lichtelemente
light elements

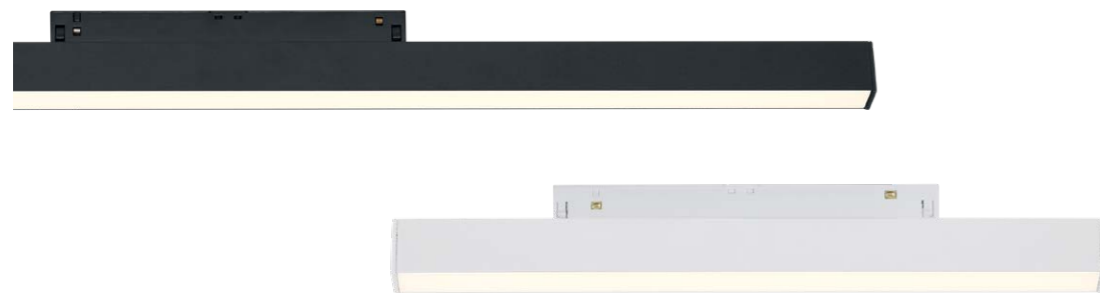

ADD-IT

Technische Daten / Technical specifications

Querschnitt / Profile

Obere Länge / Upper length (A)

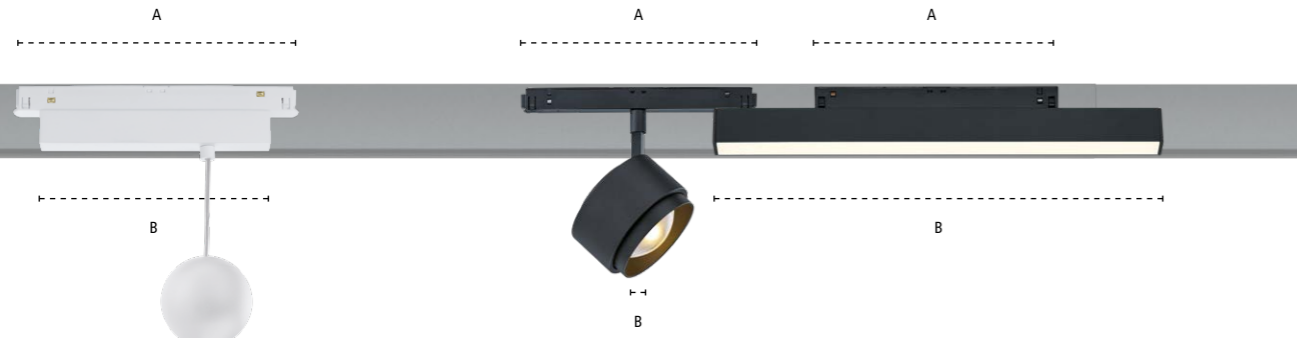

Untere Länge / Bottom length (B)

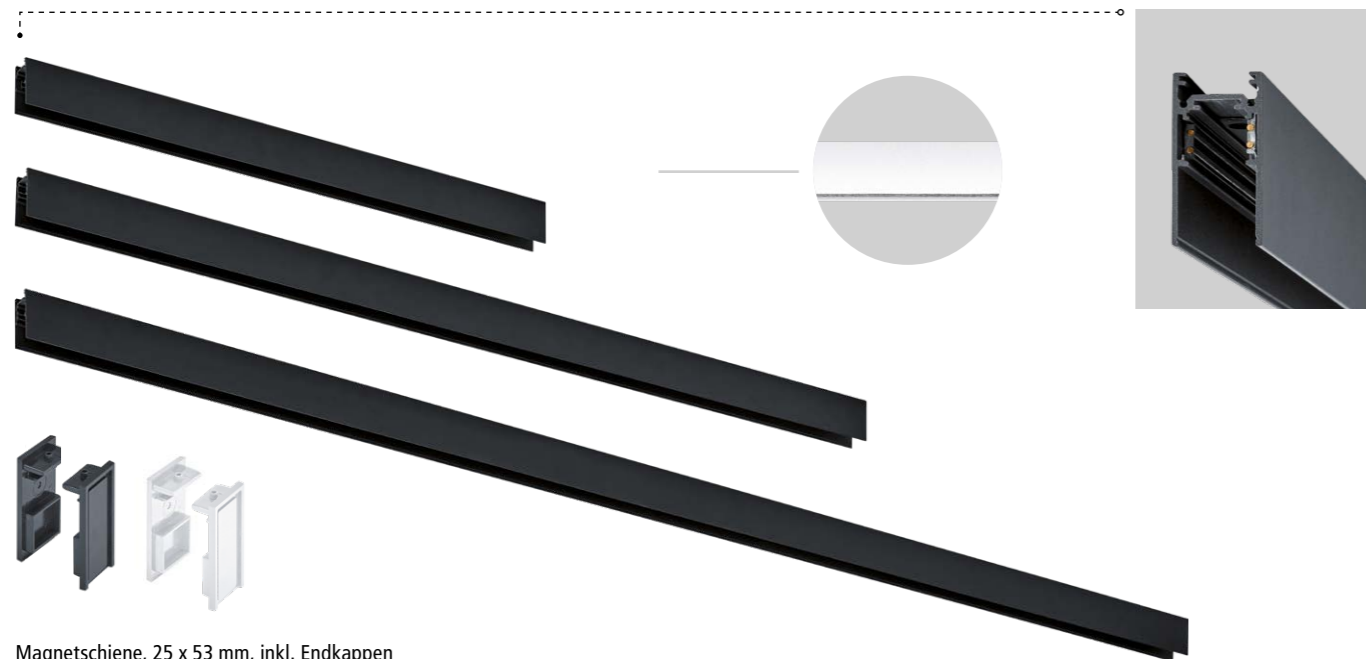

Magnetschiene, 25 x 53 mm, inkl. Endkappen
magnetic track, 25 x 53 mm, incl. end caps

			A	B
6600	Schiene 750 mm / Track 750 mm	mattschwarz / black mat	750 mm	750 mm
6650	Schiene 750 mm / Track 750 mm	mattweiß / white mat	750 mm	750 mm
6601	Schiene 1150 mm / Track 1150 mm	mattschwarz / black mat	1150 mm	1150 mm
6651	Schiene 1150 mm / Track 1150 mm	mattweiß / white mat	1150 mm	1150 mm
6602	Schiene 1650 mm / Track 1650 mm	mattschwarz / black mat	1650 mm	1650 mm
6652	Schiene 1650 mm / Track 1650 mm	mattweiß / white mat	1650 mm	1650 mm
6608	Abdeckung für Schiene / Cover for track	mattschwarz / black mat		1000 mm
6658	Abdeckung für Schiene / Cover for track	mattweiß / white mat		1000 mm



6606	Abdeckung für Deckendosen / Cover for ceiling outlet	mattweiß / matt white	80 x 80 mm
6607	Abdeckung für Deckendosen / Cover for ceiling outlet	mattschwarz / black mat	80 x 80 mm



ADD-IT

Technische Daten / Technical specifications



inkl. elektr. Verbinder
incl. electrical connector

			A	B
6604	Linienverbinder / Line connector	mattschwarz / black mat	270 mm	0 mm
6654	Linienverbinder / Line connector	mattweiß / white mat	270 mm	0 mm
6603	90°-Verbinder / 90° connector	mattschwarz / black mat	185/185 mm	0/0 mm
6653	90°-Verbinder / 90° connector	mattweiß / white mat	185/185 mm	0/0 mm
6609	T-Verbinder / T-connector	mattschwarz / black mat	185/185/185 mm	0 mm
6659	T-Verbinder / T-connector	mattweiß / white mat	185/185/185 mm	0 mm



alle Konverter inkl. Fernbedienung
all converter incl. Remote control

				A	B
6620	Konverter 60 W int / Converter 60 W int inkl. Abdeckung / including cover	systemintegriert / system-integrated	mattschwarz / black mat	300 mm	300 mm
6624	Konverter 60 W int / Converter 60 W int inkl. Abdeckung / including cover	systemintegriert / system-integrated	mattweiß / white mat	300 mm	300 mm
6622	Konverter 60 W ext / Converter 60 W ext	für externe Einspeisung / for external feed	mattschwarz / black mat	150 mm	0 mm
6625	Konverter 60 W ext / Converter 60 W ext	für externe Einspeisung / for external feed	mattweiß / white mat	150 mm	0 mm
6623	Konverter 100 W ext / Converter 100 W ext	für externe Einspeisung / for external feed	mattschwarz / black mat	150 mm	0 mm
6626	Konverter 100 W ext / Converter 100 W ext	für externe Einspeisung / for external feed	mattweiß / white mat	150 mm	0 mm



Smart-Home Einbindung möglich. Alle Informationen dazu unter
Smart-home integration is available. All information at
www.helestra.de/add-it

6605	Fernbedienung / remote control	schwarz / black
-------------	--------------------------------	-----------------

Dimmung nur über Fernbedienung möglich / Dimming only possible via remote control



mit Memoryfunktion
with memory function



6610

Smart Controller - Glas weiß
Montage und Anschluss in Standard-
Wandschalterdose. 4 Kanäle können
individuell mit Leuchten, Gruppen oder
Szenen belegt werden.
Die Konfiguration erfolgt über die
HaoDeng-App.

Smart Controller - glass white
Mounting in and wiring in standard
cavity wall box. 4 channels can be
individually assigned with luminaires,
groups or scenes.
The controller is configured by the
HaoDeng-App.



ADD-IT

Alle Leuchten / All luminaires:

2700 K, CRI > 90







Bitte den Farbschlüssel zu den Artikelnummern ergänzen:
Please complete the item number with colour code:



.07 - mattweiß / white mat
.22 - mattschwarz / black mat
.28 - mattschwarz-mattgold / black mat-matt gold



Beispiel für mattweiß / example for white mat

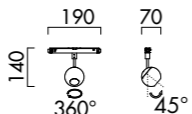

15/2155... 15/2155.07

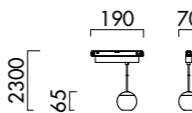
	305	22		605	22
15/2155...	Lichtelement / Light element, 305 mm	Acryldiffusor satiniert / Satinised acrylic diffuser	7,2 W, B 730 / N 380 lm	170 mm	305 mm
15/2156...	Lichtelement / Light element, 605 mm	Acryldiffusor satiniert / Satinised acrylic diffuser	14,4 W, B 1470 / N 760 lm	170 mm	605 mm

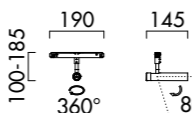

				A	B
15/2150...	BALL Strahler / BALL spot, Ø 70 mm	8,5 W, B 880 / N 550 lm, 36°	190 mm 25 mm	190 mm	25 mm



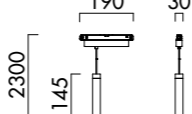

				höhenverstellbar / adjustable height	
16/2150...	BALL Pendel / BALL pendant, Ø 70 mm	8,5 W, B 880 / N 550 lm, 36°	190 mm 160 mm	A	B

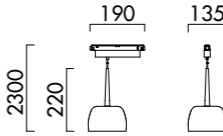

				A	B
15/2151...	TUBE Strahler / TUBE spot	4,5 W, B 520 / N 270 lm, 38°	190 mm 25 mm	190 mm	25 mm



				höhenverstellbar / adjustable height	
16/2151...	TUBE Pendel / TUBE pendant	4,5 W, B 520 / N 270 lm, 38°	190 mm 160 mm	A	B



				Ausstrahlwinkel verstellbar 15-45° adjustable beam angle 15-45°	
15/2452.07	PONT Strahler / PONT spot	mattweiß / white mat	10 W, B 960 / N 405 lm	190 mm	25 mm
15/2452.16	PONT Strahler / PONT spot	mattweiß-mattgold / white mat-gold mat	10 W, B 960 / N 405 lm	190 mm	25 mm
15/2152.22	PONT Strahler / PONT spot	mattschwarz / black mat	10 W, B 960 / N 405 lm	190 mm	25 mm
15/2152.28	PONT Strahler / PONT spot	mattschwarz-mattgold / black mat-matt gold	10 W, B 960 / N 405 lm	190 mm	25 mm

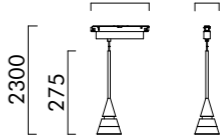

				höhenverstellbar / adjustable height	
16/2153.22	FLUTE Pendel / FLUTE pendant	mattschwarz / black mat	6 W, B 680 / N 440 lm	190 mm	160 mm
16/2153.22/5284	FLUTE Pendel / FLUTE pendant	Glas klar / Glass clear	6 W, B 680 / N 440 lm	190 mm	160 mm
16/2153.22/5285	FLUTE Pendel / FLUTE pendant	Glas grau / Glass gray	6 W, B 680 / N 440 lm	190 mm	160 mm

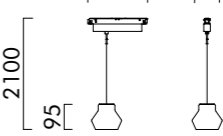
				höhenverstellbar / adjustable height	
16/2154...	DEEP Pendel / DEEP pendant, Ø 80 mm	5 W, B 560 / N 450 lm	190 mm 160 mm	A	B

				höhenverstellbar / adjustable height	
16/2158...	CONE Pendel / CONE pendant, Ø 80 mm	5 W, B 560 / N 440 lm	190 mm 160 mm	A	B

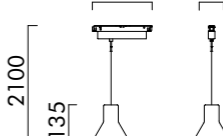
				höhenverstellbar / adjustable height	
16/2351.../5324	LETO Pendel / LETO pendant	6 W, B 440 / N 380 lm	190 mm 160 mm	A	B

				höhenverstellbar / adjustable height	
16/2351.../5325	LETO Pendel / LETO pendant	6 W, B 440 / N 380 lm	190 mm 160 mm	A	B

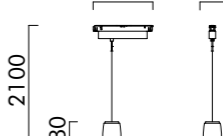
				höhenverstellbar / adjustable height	
16/2350...	COPA Pendel / COPA pendant	6 W, B 440 / N 380 lm	190 mm 160 mm	A	B



VIGO

THE MODULAR LED SYSTEM

VIGO ist ein modular erweiterbares System, dass insbesondere mit seiner minimalistischen Aufbauhöhe, hoher Flexibilität, einfacher Planbarkeit und Montagefreundlichkeit überzeugt. VIGO-Konverter können wahlweise im System integriert oder in Wand bzw. Decken verbaut werden. VIGO ist über die mitgelieferte Fernbedienung komfortabel schalt- und dimmbar.

VIGO is an impressive modular system, capable of being expanded easily and notable for its minimal installation height, high degree of flexibility, and ease of planning and assembly. VIGO drivers can be integrated into your system or built into walls or ceilings. With VIGO you can easily dim the lights or switch them on or off using the remote control device that comes with this product.

Bei der Planung hilft Ihnen auch unser Konfigurator auf unserer Website:

Our configurator on our website will also help you with planning:

www.helestra.de/vigo

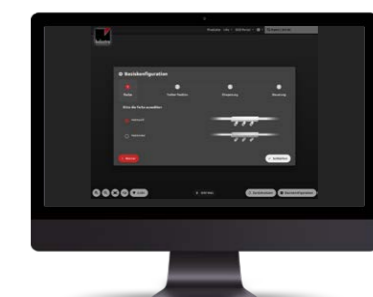

VIGO

Systemleistung 86,4 W / system wattage 86,4 W - 11430 lm
Systemlänge 4680 mm / system length 4680 mm
externe Einspeisung / external power supply



- 1 3 x 15/1602.18 LED-Modul 28,8 W / LED-module 28,8 W
- 2 1 x 6021 Konverter 100 W / converter 100 W
- 3 1 x 6010.18 Endeinspeisung / end feeder
- 4 1 x 6001.18 Linienverbinder / line connector
- 5 1 x 6002.18 Verbinder 90° / 90°-connector
- 6 1 x 6000.18 Endstück / end fitting



VIGO

Systemleistung 96 W / system wattage 96 W - 12700 lm
Systemlänge 5520 mm / system length 5520 mm
systemintegrierte Einspeisung / intergrated power supply

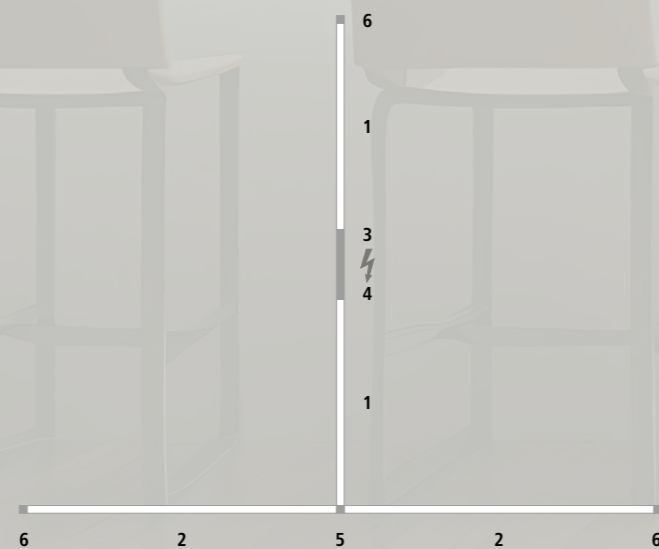

- 1 2 x 15/1601.07 LED-Modul 19,2 W / LED-module 19,2 W
- 2 2 x 15/1602.07 LED-Modul 28,8 W / LED-module 28,8 W
- 3 1 x 6021 Konverter 100 W / converter 100 W
- 4 1 x 6031.07 Mitteleinspeisung / middle feeder
- 5 1 x 6003.07 T-Verbinder / T-connector
- 6 3 x 6000.07 Endstück / end fitting



VIGO

Systemleistung 97,9 W / system wattage 97,9 W - 12950 lm
Systemlänge 5325 mm / system length 5325 mm
externe Einspeisung / externe power supply

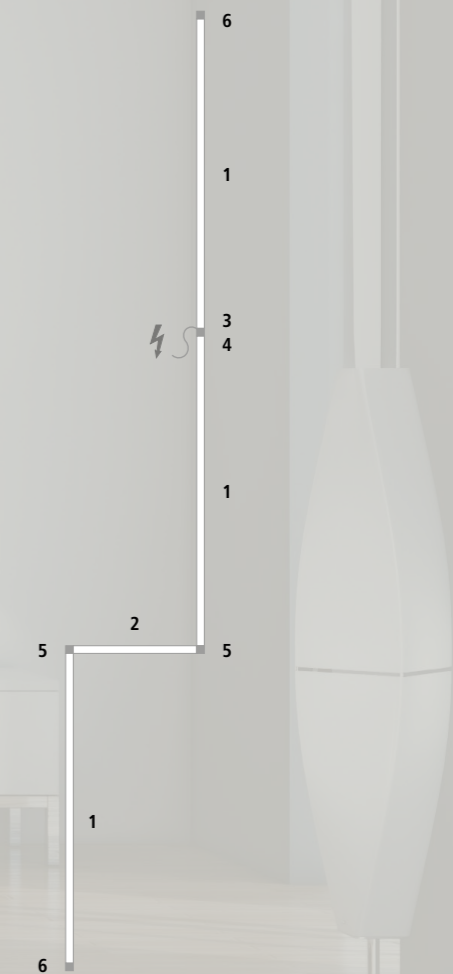

- 1 3 x 15/1602.18 LED-Modul 28,8 W / LED-module 28,8 W
- 2 1 x 15/1600.18 LED-Modul 11,5 W / LED-module 11,5 W
- 3 1 x 6021 Konverter 100 W / converter 100 W
- 4 1 x 6011.18 Linieneinspeisung / line feeder
- 5 2 x 6002.18 Verbinder 90° / 90°-connector
- 6 2 x 6000.18 Endstück / end fitting



VIGO

- System stufenlos dimmbar mit Memory-Funktion
- Steuerung wahlweise über Fernbedienung oder Wandsender
- bis zu 5 Fernbedienungen/Wandsender je System möglich
- eine Fernbedienung/Wandsender für mehrere Systeme möglich
- System infinitely dimmable with memory function
- control optionally by remote control or wall-mounted transmitter
- up to 5 remote controls/wall-mounted transmitters for each system
- one remote control or wall-mounted transmitter can control multiple systems



VIGO

Aufbausystem für Decken
oder Wandmontage
surface mounted ceiling
or wall system
3000 K, CRI > 85



Bestellschritte für Ihr VIGO System. How to configure your VIGO system.

Bitte max. mögliche Gesamtsystemleistung von 100 W beachten.
Please be aware of max. system wattage of 100 W.

Einspeisung power supply		Lichtmodule / Verbinder Light modules / connectors	
1	+	2 extern external	oder/or
		3 intern internally	
		4	+
		5	

Bitte den Farbschlüssel zu den Artikelnummern ergänzen:
Please complete the item number with colour code:

.07 - mattweiß / white mat
.18 - mattnickel eloxiert / nickel mat anodised
.22 - mattschwarz / black mat

Beispiel für mattweiß / example for white mat

6000... 6000.07

1 Konverter inkl. Dimm-Modul und Fernbedienung converter incl. dim-module and remote control



60 W
6020
100 W
6021

Konverter inkl. Dimm-Modul und Wandsender converter incl. dim-module and wall transmitter



60 W
6020.1
100 W
6021.1



* inkl. Magnetbefestigung / * incl. magnetic mount

2 Verbinder* inkl. Kabeleinspeisung (L 900 mm) für extern verbaute Konverter connectors* incl. cable feeder (L 900 mm) for external converters



Endstück / end fitting
6010...



Linienverbinder / line connector
6011...

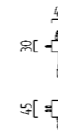

90°-Verbinder / 90°-connector
6012...



T-Verbinder / T-connector
6013...

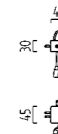

3 Deckengehäuse für Konverter housing for converter



Endeinspeisung / end feeder
6030...

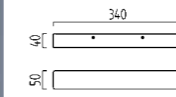

Mitteinspeisung / middle feeder
6031...

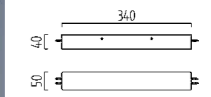

8,2 W, B 940 / N 720 lm



Endeinspeisung / end feeder
25/1730...



12,2 W, B 1410 / N 1080 lm



Endeinspeisung / end feeder
35/1730...



Mitteinspeisung / middle feeder
25/1731...



Mitteinspeisung / middle feeder
35/1731...



**4 Lineare LED-Module*
linear LED-modules***

Acryldiffusor satiniert
acrylic diffuser satinised

11,5 W, B 1600 / N 1310 lm
15/1600...

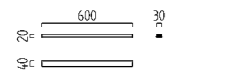

18 W, B 2760 / N 2180 lm
15/1601...

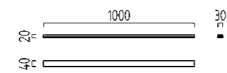

26,5 W, B 4210 / N 3270 lm
15/1602...

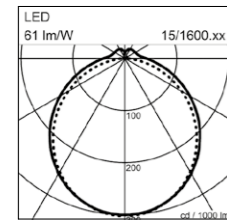
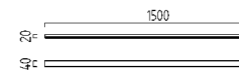

**5 Verbinder*
connectors***



Endstück / end fitting
6000...



Linienverbinder / line connector
6001...



90°-Verbinder / 90°-connector
6002...



T-Verbinder / T-connector
6003...



Verbinder 90° vertikal,
Decke-Wand / Wand-Wand
connector 90° vertical,
ceiling-wall / wall-wall
6004...

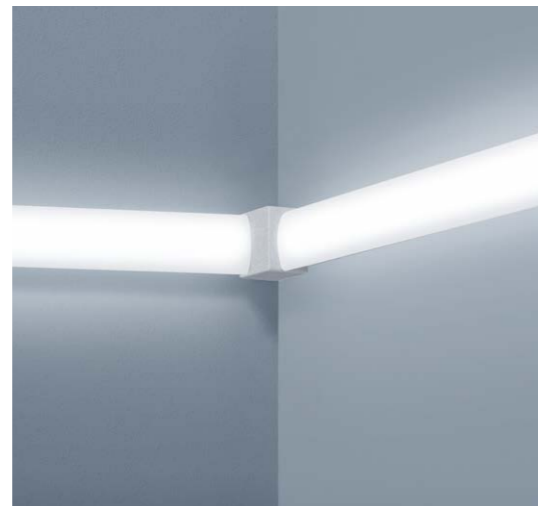

* inkl. Magnetbesfestigung / * incl. magnetic mount



**5 LED-Strahlermodule
LED-spotlights**

4 W, B 470 / N 360 lm



Endstück / end fitting
15/1700...



Linienverbinder / line connector
15/1701...



90°-Verbinder / 90°-connector
15/1702...



T-Verbinder / T-connector
15/1703...



8,2 W, B 940 / N 720 lm



Endelement / end element
25/1730...

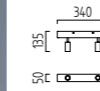

Mittелеlement / middle element
25/1731...

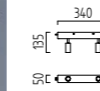

12,2 W, B 1410 / N 1080 lm



Endelement / end element
35/1730...

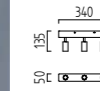

Mittелеlement / middle element
35/1731...

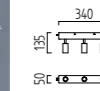

LIGHT IS OUTSIDE®



BICA-Q
282–283

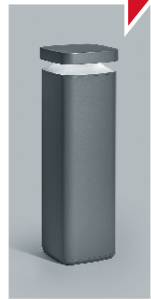

BICA-R
284–285

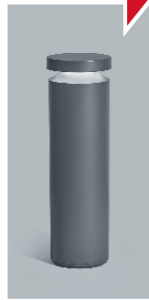

BICA
286–289

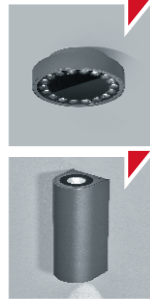

POSH
290–291

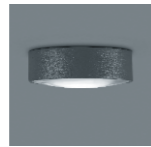

ISY
292–295

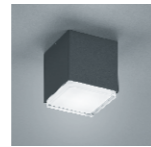

NORSA
296–297



CILA
298–299



ANOU
300–301

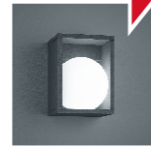

OKI
302–305



SIRI 44
306–309

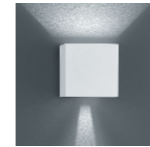

SIRI 44-L
310–311

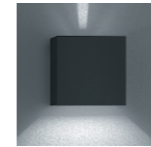

SIRI 44-R
312–313

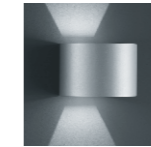

SKY
314–315



MONO
316–317

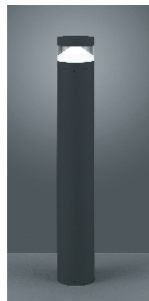

PIER
318–319



TENDO
320–321



SCALA
322–323



KAPO
324–325



SWIFT
326–327

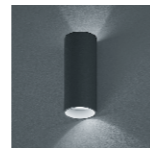

PEKA
328–329

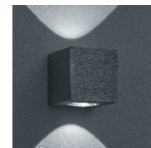

KIBO
330–331



FREE
332–333

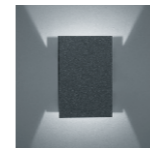

AIR
334–335

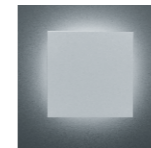

TOUR
336–337

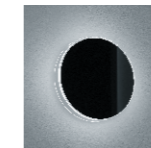

SKIP
338–339



MORIS XL
340–341



MORIS
342–343

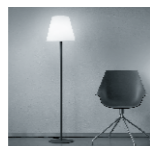

KORI
344–345



SIN
346–347



AIR	334–335
ANOU	300–301
BICA	286–289
BICA-Q	282–283
BICA-R	284–285
CILA	298–299
FREE	332–333
ISY	292–295
KAPO	324–325
KIBO	330–331
KORI	344–345
MONO	316–317
MORIS	342–343
MORIS XL	340–341
NORSA	296–297
OKI	302–305
PEKA	328–329
PIER	318–319
POSH	290–291
SCALA	322–323
SIN	346–347
SIRI 44	306–309
SIRI 44-L	310–311
SIRI 44-R	312–313
SKIP	338–339
SKY	314–315
SWIFT	326–327
TENDO	320–321
TOUR	336–337
Zubehör / Accessories	349

BICA-Q

LED IP65 IK08 YL Plus

Aluminium Druckguss
graphit
Linse UV-beständig für breitstrahlende Lichtverteilung
die casting aluminium
graphite
uv resistant lens for wide beam

24 W, 3000 K, B 2700 / N 1160 lm, CRI > 85
A192303.93



Zubehör für Bodenbefestigung
accessories for floor assembly
Seite / page 349



BICA-R

LED IP65 IK08 YL Plus

Aluminium Druckguss
graphit
Linse UV-beständig für breitstrahlende Lichtverteilung
die casting aluminium
graphite
uv resistant lens for wide beam

24 W, 3000 K, B. 2700 / N 1160 lm, CRI > 85
A192301.93

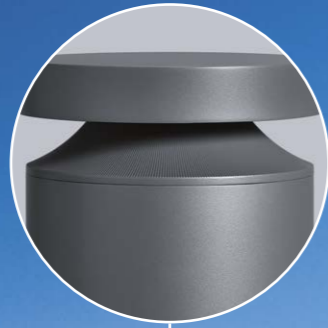

Zubehör für Bodenbefestigung
accessories for floor assembly
Seite / page 349



BICA

LED IP65 IK07 YL Plus

Aluminium Druckguss
graphit
Glasabdeckung klar
Abstrahlwinkel 36°
die casting aluminium
graphite
glass cover clear
beam angle 36°



24 W, 3000 K, B 2700 / N 1320 lm, CRI > 85
A282305.93



Blende, 2er-Set / glare shield, set of 2
9050

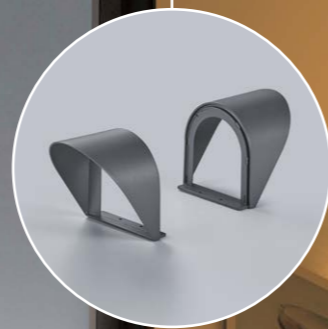

BICA

LED IP65 IK05 YL Plus

Aluminium Druckguss
graphit
Glasabdeckung klar
Abstrahlwinkel 48°
die casting aluminium
graphite
glass cover clear
beam angle 48°

13 W, 3000 K, B 1380 / N 1020 lm, CRI > 85
A152306.93



25 W, 3000 K, B 2830 / N 2090 lm, CRI > 85
A152307.93

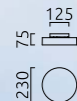

Montage flach an der Decke oder abgesetzt mit
Distanzring möglich
Installation flush to ceiling or with spacer plate



POSH

LED IP65

Aluminium Druckguss
Glaslinse klar
die-casting aluminium
glass lens clear

230 V - 6 W, 3000 K, B 520 / N 320 lm, CRI > 85



graphit / graphite
A152005.93

mattweiß / white mat
A152005.07

Ø 110



www.helestra.de/posh

291



ISY

LED IP54

Aluminium massiv
graphit
Glas satiniert
solid aluminium
graphite
glass satinised



11 W, 3000 K, B 1120 / N 690 lm, CRI > 85
A15901.93

120 120
135 135
120 120



ISY

LED IP54

Aluminium massiv
graphit
Glas satiniert
schwenkbar
solid aluminium
graphite
glass satinised
tiltable

13 W, 3000 K, B 1440 / N 810 lm, CRI > 85
A19901.93

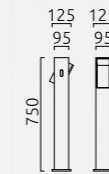

Zubehör für Bodenbefestigung
accessories for floor assembly
Seite / page 349

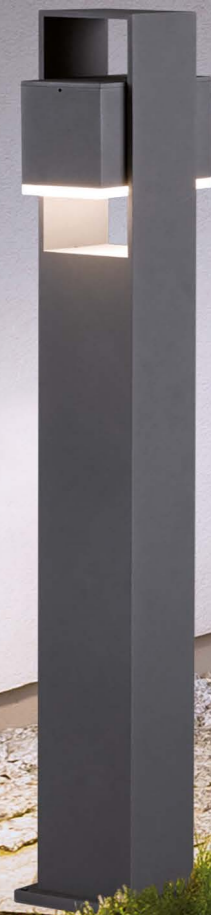

NORSA

LED IP54 **YL**
Plus

Aluminium
graphit
kipppbar
aluminium
graphite
tiltable

A192203.93

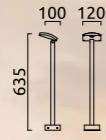

10,5 W, 3000 K, B 1080 lm /
N 710 lm, CRI > 90

A182203.93

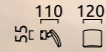

Zubehör für Bodenbefestigung
accessories for floor assembly
Seite / page 349



CILA

LED IP65 YL Plus

Aluminium
graphit
Acryl satiniert
schwenkbar
aluminium
graphite
acrylic satinised
tiltable

12 W, 3000 K, B 1260 / N 780 lm, CRI > 90
A292201.93

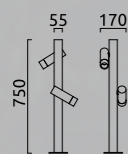

Zubehör für Bodenbefestigung
accessories for floor assembly
Seite / page 349





ANOU

LED IP65 YL Plus

Aluminium
graphit
Acryl satiniert
aluminium
graphite
acrylic satinised

8,3 W, 3000 K, B 720 / N 590 lm, CRI > 90

A192202.93

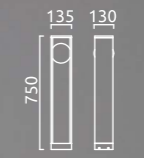

Zubehör für Bodenbefestigung
accessories for floor assembly
Seite / page 349



A182202.93



OKI

LED IP54

Aluminium massiv
Acrylglas satiniert
solid aluminium
acrylic glass satinised

25 W, 3000 K, B 2810 / N 1360 lm, CRI > 85

graphit / graphite
A19803.93



Zubehör für Bodenbefestigung
accessories for floor assembly
Seite / page 349



OKI

LED  IP54

Aluminium massiv
Acrylglas satiniert
solid aluminium
acrylic glass satinised

8 W, 3000 K, B 880 / N 520 lm, CRI > 85

graphit / graphite
A18803.93

160 170



SIRI 44

LED IP54

Aluminium massiv
graphit
solid aluminium
graphite

7 W, 3000 K, B 680 / N 320 lm, CRI > 90

A19802.73

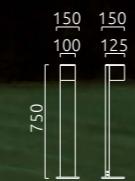

Zubehör für Bodenbefestigung
accessories for floor assembly
Seite / page 349



SIRI 44

LED  IP54

Aluminium massiv
solid aluminium

7 W, 3000 K, B 720 / N 390 lm, CRI > 90

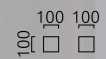
 100 100
80 80

mattweiß / white mat

A28242.07

mattnickel eloxiert / nickel mat anodised

A28242.18

silbergrau / silver grey

A28242.46

graphit / graphite

A28242.73

mattschwarz / black mat

A28242.93

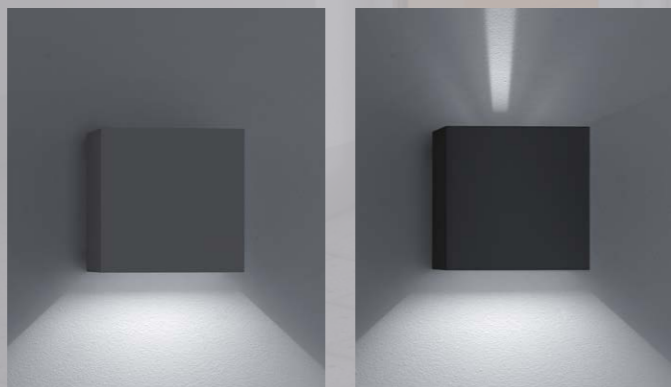
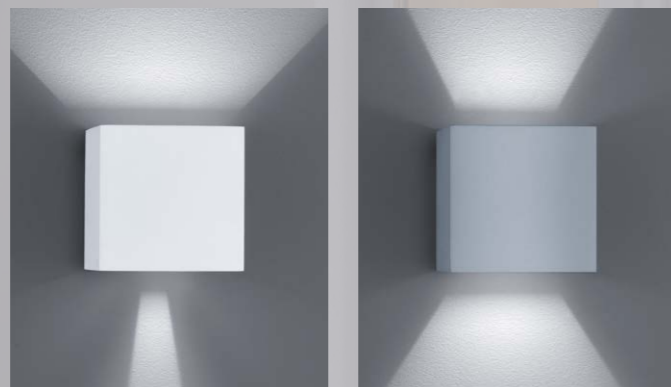

Lichtaustritt stufenlos verstellbar
light beam infinitely adjustable



SIRI 44-L

LED  IP54

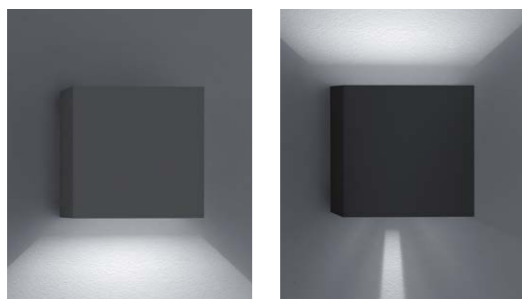
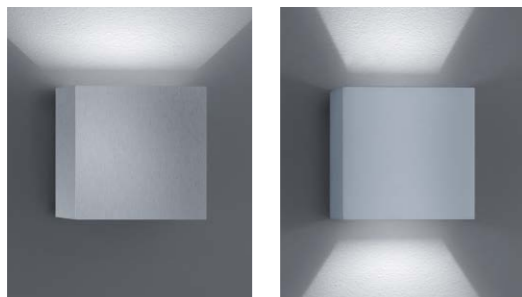

Aluminium massiv
solid aluminium

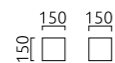

15 W, 3000 K, B 1550 / N 850 lm, CRI > 90

mattweiß / white mat
A28442.07

mattnickel eloxiert / nickel mat anodised
A28442.18

silbergrau / silver grey
A28442.46

graphit / graphite
A28442.73

mattschwarz / black mat
A28442.93



SIRI 44-R

LED  IP54

Aluminium massiv
solid aluminium

7 W, 3000 K, B 720 / N 390 lm, CRI > 90

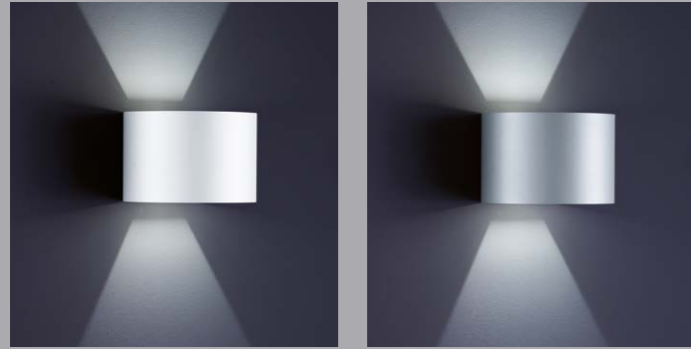

mattweiß / white mat
A28342.07

silbergrau / silver grey
A28342.46

mattschwarz / black mat
A28342.93

150

100

75



Lichtaustritt stufenlos verstellbar
light beam infinitely adjustable



SKY

LED IP54

Aluminium massiv
graphit
solid aluminium
graphite

8,5 W, 3000 K, B 840 / N 420 lm, CRI > 90
A19501.93



Zubehör für Bodenbefestigung
accessories for floor assembly
Seite / page 349



MONO

LED IP54

Aluminium massiv
solid aluminium

10 W, 3000 K, B 1090 / N 290 lm, CRI > 90

graphit / graphite
A19700.93

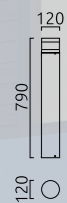

Zubehör für Bodenbefestigung
accessories for floor assembly
Seite / page 349



PIER

LED IP55

Aluminium massiv
graphit
Acryldiffusor satiniert
solid aluminium
graphite
acrylic diffuser satinised

52 W, 3000 K, B 6530 / N 1790 lm,
CRI > 85
A39500.93



Zubehör für Bodenbefestigung
accessories for floor assembly
Seite / page 349



TENDO

LED IP55

Aluminium massiv
graphit
Acryldiffusor satiniert
solid aluminium
graphite
acrylic diffuser satinised



43 W, 3000 K, B 5800 / N 2030 lm, CRI > 80
A29412.93



61 W, 3000 K, B 7540 / N 2640 lm, CRI > 80
A29912.93

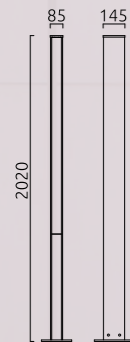

Auf Anfrage sind Sonderfarben nach RAL möglich.
Special colours (RAL) on request.

Zubehör für Bodenbefestigung
accessories for floor assembly
Seite / page 349





SCALA

LED IP44

Acryldiffusor weiß
acrylic diffuser white



13 W, 3000 K, B 1400 / N 840 lm, CRI > 85

Edelstahl / stainless steel
A18454.86

graphit / graphite
A18454.93

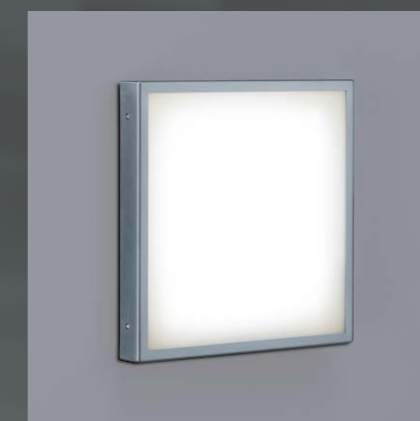

27 W, 3000 K, B 2990 / N 1790 lm, CRI > 85

Edelstahl / stainless steel
A18457.86

graphit / graphite
A18457.93



KAPO

LED   Casambi  IP54



Aluminium
graphit
Acryl satiniert
aluminium
graphite
acrylic satinised

8 W, 3000 K, B 820 / N 510 lm, CRI > 85
A18610.93



SWIFT

LED  IP65



Aluminium massiv
solid aluminium

7 W, 3000 K, B 720 / N 590 lm, CRI > 90

graphit / graphite
A28704.93

75
180
75





PEKA

LED IP54

Aluminium massiv
solid aluminium

5 W, 3000 K, B 540 / N 380 lm, CRI > 90



graphit / graphite
A28807.93

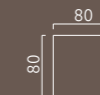

KIBO

LED IP54



Aluminium
Acryl weiß
aluminium
acrylic white

11 W, 3000 K, B 1140 / N 520 lm, CRI > 85

mattweiß / white mat
A28612.07

graphit / graphite
A28612.93

90 80
105 □ □



FREE

LED IP54



Aluminium massiv
Lichtaustritt verstellbar
solid aluminium
light beam adjustable

10 W, 3000 K, B 990 / N 520 lm, CRI > 90

graphit / graphite
A18605.93

150 70 100
150 70 100



AIR

LED IP65

Aluminium massiv
solid aluminium

15 W, 3000 K, B 1590 / N 410 lm, CRI > 90

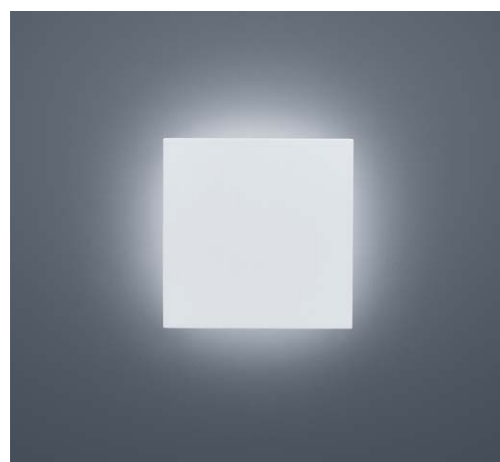

mattweiß / white mat
A18607.07

graphit / graphite
A18607.93

45 150
150 150





TOUR

LED IP65

Aluminium Druckguss
Sicherheitsglas
die-casting aluminium
tempered glass

13 W, 3000 K, B 1360 / N 350 lm, CRI > 90



Glas weiß - Rand klar / glass white - edge clear
A182004.07

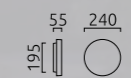

SKIP

E27  IP44

Aluminium massiv
graphit
Acrylglas klar
solid aluminium
graphite
acrylic glass clear

1 x E27



A18805.93

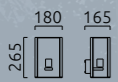

Leuchtmittel nicht im Lieferumfang
bulb not included





MORIS XL

E27  IP44

graphit
witterungsbeständiges Acryl weiß
Zuleitungslänge 3 m
graphite
weather resistant white acrylic
power supply line 3 m

1 x E27

Leuchtmittel nicht im Lieferumfang
bulb not included

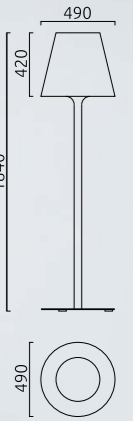

17/2166.93



MORIS

E27 IP65

witterungsbeständiges Acryl, weiß
Zuleitungslänge 4,5 m
weather resistant white acrylic
power supply line 4,5 m

1 x E27

silbergrau / silver grey
19/1266.46

graphit / graphite
19/1266.93

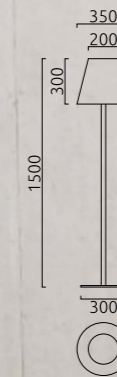

Leuchtmittel nicht im Lieferumfang
bulb not included



KORI

LED  IP65

Mobile Akkuleuchte
wiederaufladbar, inkl. USB-Ladekabel
Akku-Laufzeit ca. 8 Std. (100% Lichtleistung)
portable battery light
rechargeable, incl. USB charging cable
battery operating time appr. 8 hrs (100% light intensity)

2,2 W, 2700 K, B 210 / N 120 lm, CRI > 85



mattweiß / white mat
19/2100.07

rostbraun / rubiginous
19/2100.49

mattschwarz / black mat
19/2100.98

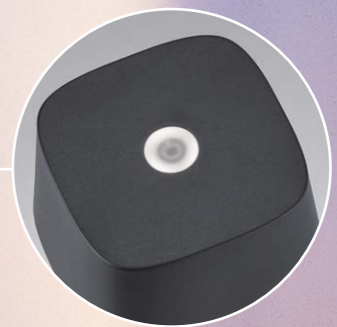
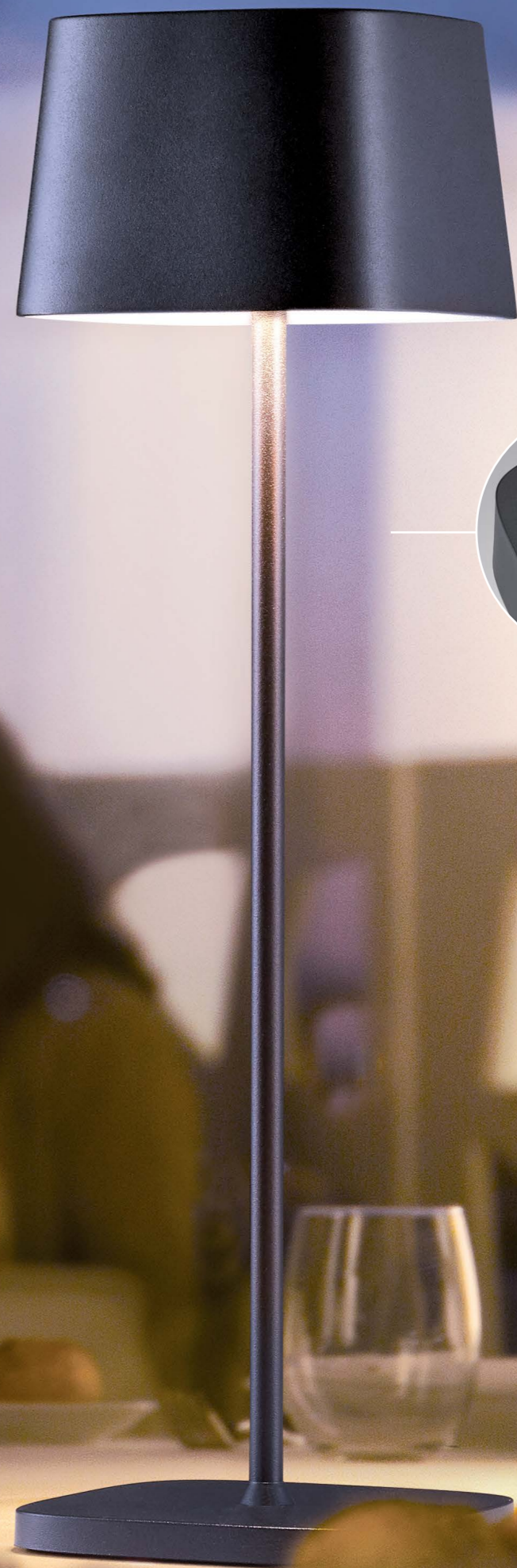

SIN

LED IP65 IK08 YL Plus

Einbauleuchte - inkl. Montagebox
wall recessed luminaire - incl. installation box

4 W, 3000 K, B 280 / N 170 lm, CRI > 90



mattweiß / white mat
A182308.07

graphit / graphite
A182308.93

105.4 110
100 100





Zubehör Außenleuchten Accessories outdoor lighting

Montage von Pollerleuchten

Alle Pollerleuchten können ohne Zubehör auf einem Fundament verschraubt oder alternativ mit einem Erdstück und einer Adapterplatte gemäß unten stehender Tabelle im Erdboden befestigt werden.

Mounting of bollards

All bollards can be bolted to a solid base without accessories or mounted in-ground with anchorage unit and adapter plate (see list below).

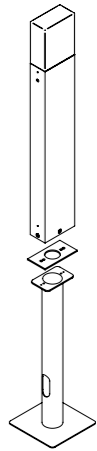

Serie	Erdstück - Stahl verzinkt anchorage unit - steel galvanised	Adapterplatte - Stahl verzinkt adapter plate - steel galvanised
ANOU	A19900	9036
BICA	A19900	9039
CILA	A19900	9037
ISY	A19900	9034
MONO	A19900	9029
NORSA	A19900	9038
OKI	A19900	9032
PIER	A19900	9024
SIRI 44	A19900	9031
SKY	A19900	9019
TENDO A29412...	A19900	9018
TENDO A29912...	A19900	9007

A19900

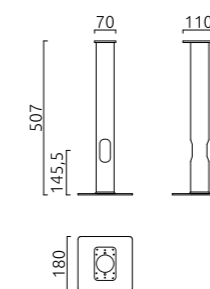

Art.-Nr./art. no.	Seite/page	Art.-Nr./art. no.	Seite/page	Art.-Nr./art. no.	Seite/page	Art.-Nr./art. no.	Seite/page	Art.-Nr./art. no.	Seite/page	Art.-Nr./art. no.	Seite/page	Art.-Nr./art. no.	Seite/page	Art.-Nr./art. no.	Seite/page
15...		15/1945.06	159	15/2415.07-22	162	16/2351.07/5324	263	18/2026.04	204	25/2402.22	13	6001.18	276	9032	349
15/1552.07	249	15/1945.07	159	15/2415.22-07	162	16/2351.07/5325	263	18/2031.04	210	25/2402.28	13	6001.22	276	9034	349
15/1552.22	249	15/1945.22	159	15/2415.22-09	162	16/2351.22/5324	263	18/2032.04	210	26...		6002.07	276	9036	349
15/1552.26	249	15/1946.06	161	15/2415.22-22	162	16/2351.22/5325	263	18/2033.04	210	26/1641.27/5210	50	6002.18	276	9037	349
15/1553.07	249	15/1946.07	161	15/2416.07	117	16/2403.22	20	18/2035.25	139	26/1692.07	101	6002.22	276	9038	349
15/1553.22	249	15/1946.22	161	15/2416.07-DALI	117	16/2403.28	20	18/2037.04	202	26/1692.22	101	6003.07	276	9039	349
15/1553.26	249	15/1950.04	233	15/2416.22	117	16/2404.28	16	18/2037.22	200	26/1792.07	101	6003.18	276	9050	286
15/1558.07	155	15/1951.04	233	15/2416.22-DALI	117	16/2404.28/5346	16	18/2038.04	202	26/1792.22	101	6003.22	276	96...	
15/1600.07	276	15/1954.07	122	15/2417.07	118	16/2404.64	16	18/2038.22	200	26/1847.04/9276	87	6004.07	276	96/2311.22	38
15/1600.18	276	15/1954.09	122	15/2417.07-DALI	118	16/2404.64/5346	16	18/2039.04	202	26/1847.04/9283	87	6004.18	276	115...	
15/1600.22	276	15/1954.22	122	15/2417.22	118	16/2405.64/5345	25	18/2039.22	200	26/1847.04/9288	87	6004.22	276	115/2212.07	132
15/1601.07	276	15/1956.07	122	15/2417.22-DALI	118	17...		18/2040.04	202	26/1847.04/9289	87	6010.07	275	115/2212.22	132
15/1601.18	276	15/1956.09	122	15/2429.07	180	17/1036.22	74	18/2040.22	200	26/1847.04/9290	87	6010.18	275	A15...	
15/1601.22	276	15/1956.22	122	15/2429.07-4	180	17/1240.34/5045	68	18/2116.07	142	26/1892.07	102	6010.22	275	A152005.07	290
15/1602.07	276	15/1964.07	174	15/2429.22	180	17/1240.34/5096	68	18/2120.04	217	26/2009.07	59	6011.07	275	A152005.93	290
15/1602.18	276	15/1964.22	174	15/2429.22-4	180	17/1240.84/5045	68	18/2121.04	217	26/2009.22	59	6011.18	275	A152306.93	288
15/1602.22	276	15/1993.07	113	15/2452.07	262	17/1505.19	64	18/2122.04	217	26/2430.07	105	6011.22	275	A152307.93	288
15/1629.07	247	15/1993.09	113	15/2452.16	262	17/1505.22	64	18/2123.04	241	26/2430.22	105	6012.07	275	A15901.93	293
15/1629.22	247	15/1993.22	113	16...		17/1849.34/9289	83	18/2123.07	141	26/2431.07	105	6012.18	275	A18...	
15/1632.07	98	15/2012.00	183	16/1504.19	61	17/1849.34/9290	83	18/2308.22	141	26/2431.22	105	6012.22	275	A182004.07	337
15/1632.22	98	15/2013.07	168	16/1644.19	61	17/2008.22/9319	81	18/2402.22	13	27...		6013.07	275	A182202.93	301
15/1700.07	277	15/2013.22	168	16/1722.26	63	17/2008.22/9320	81	18/2402.28	13	27/1502.19	67	6013.18	275	A182203.93	296
15/1700.18	277	15/2034.04	253	16/1847.04/9276	84	17/2166.93	341	18/2410.07-07	111	27/1502.22	67	6013.22	275	A182308.07	346
15/1700.22	277	15/2034.07	253	16/1847.04/9283	84	17/2310.28	76	18/2410.07-09	111	27/2304.22	78	6020	274	A182308.93	346
15/1701.07	277	15/2034.22	253	16/1847.04/9288	84	17/2402.22	10	18/2410.07-50	111	27/2311.07	40	6020.1	274	A18454.86	323
15/1701.18	277	15/2041.00	250	16/1847.04/9289	84	17/2402.28	10	18/2410.22-07	111	27/2311.22	40	6021	274	A18454.93	323
15/1701.22	277	15/2105.04	230	16/1847.04/9290	84	18...		18/2410.22-09	111	28...		6021.1	274	A18457.86	323
15/1702.07	277	15/2105.06	230	16/2001.04	26 / 29	18/1175.07	152	18/2410.22-50	111	28/1427.07	146	6030.07	275	A18457.93	323
15/1702.18	277	15/2124.04	236	16/2001.64	26 / 29	18/1175.26	152	18/2411.07	188	28/1427.25	146	6030.18	275	A18605.93	333
15/1702.22	277	15/2125.04	236	16/2007.22	52	18/1328.07	148	18/2411.25	188	28/2114.07	136	6030.22	275	A18607.07	334
15/1703.07	277	15/2129.07	176	16/2107.22/5300	72	18/1328.26	148	18/2420.04	194	28/2114.28	136	6031.07	275	A18607.93	334
15/1703.18	277	15/2129.22	176	16/2107.22/5301	72	18/1807.06	144	18/2420.22	194	28/2330.07-50	108	6031.18	275	A18610.93	324
15/1703.22	277	15/2150.07	262	16/2109.22	57	18/1807.07	144	18/2421.04	194	28/2330.09-50	108	6031.22	275	A18803.93	304
15/1732.07	98	15/2150.22	262	16/2110.09	34	18/1812.04	213	18/2421.22	194	28/2330.22-50	108	61...		A18805.93	338
15/1732.22	98	15/2150.28	262	16/2110.22	34	18/1812.22	213	18/2422.04	194	35...		6100	353	A19...	
15/1735.07/5239	135	15/2151.07	262	16/2150.07	262	18/1813.04	213	18/2422.22	194	35/1730.07	275 / 277	65...		A192202.93	301
15/1735.07/5240	135	15/2151.22	262	16/2150.22	262	18/1813.22	213	18/2423.04	214	35/1730.18	275 / 277	65/2309.07	130	A192203.93	296
15/1735.07/5241	135	15/2151.28	262	16/2150.28	262	18/1814.04	213	18/2423.22	214	35/1730.22	275 / 277	65/2309.22	130	A192301.93	284
15/1745.19/9258	93	15/2152.22	262	16/2151.07	262	18/1814.22	213	18/2424.04	214	35/1731.07	275 / 277	66...		A192303.93	283
15/1745.19/9259	93	15/2152.28	262	16/2151.22	262	18/1815.04	221 / 222	18/2424.22	214	35/1731.18	275 / 277	6600	258	A19501.93	315
15/1745.19/9292	93	15/2155.07	262	16/2151.28	262	18/1816.04	221 / 222	18/2425.04	214	35/1731.22	275 / 277	6601	258	A19700.93	316
15/1800.07/9277	88	15/2155.22	263	16/2153.22	263	18/1817.04	221 / 222	18/2425.22	214	35/1806.07	167	6602	258	A19700.93	316
15/1800.07/9278	88	15/2156.07	262	16/2153.22/5284	263	18/1825.04	209	19...		35/1806.22	167	6603	260	A19803.93	302
15/1800.07/9281	88	15/2156.22	262	16/2153.22/5285	263	18/1825.22	207	19/1138.10	95	36...		6604	260	A19900	349
15/1804.07	156	15/2164.07	174	16/2154.07	263	18/1826.04	209	19/1139.10	95	36/1901.18	49	6605	261	A19901.93	295
15/1804.22	156	15/2164.22	174	16/2154.22	263	18/1826.22	207	19/1266.46	343	36/1901.22	49	6606	259	A28...	
15/1805.07	156	15/2210.22	125	16/2154.28	263	18/1827.04	209	19/1266.93	343	36/2002.04	26 / 29	6607	259	A282305.93	286
15/1805.22	156	15/2211.22	125	16/2158.07	263	18/1827.22	207	19/1943.07	97	36/2002.64	26 / 29	6608	258	A28242.07	308
15/1806.07	167	15/2215.07-07	162	16/2158.22	263	18/1828.04	209	19/1943.28	97	36/2403.22	23	6609	260	A28242.18	308
15/1806.22	167	15/2215.07-09	162	16/2158.28	263	18/1828.22	207	19/2100.07	344	36/2403.28	23	6610	261	A28242.46	308
15/1808.07	171	15/2215.07-22	162	16/2214.07	43	18/1833.04	218	19/2100.49	344	36/2405.64/5345	25	6620	260	A28242.73	308
15/1820.04	235	15/2215.22-07	162	16/2214.22	43	18/1833.22	218	19/2100.98	344	38...		66/2108.06/5303	36	A28242.93	308
15/1821.04	235	15/2215.22-09	162	16/2302.07-07	33	18/1834.04	218	19/2402.22	10	38/1427.07	146	66/2108.22/5303	36	A28342.07	312
15/1822.04	238	15/2215.22-22	162	16/2302.07-09	33	18/1834.22	218	19/2402.28	10	38/1427.25	146	6622	260	A28342.46	312
15/1822.22	238	15/2216.07-07	162	16/2302.07-22	33	18/1835.04	218	25...		45...		6623	260	A28342.93	312
15/1823.04	238	15/2216.07-09	162	16/2302.22-07	33	18/1835.22	218	25/1730.07	275 / 277	45/2309.07	130	66/2307.22	46	A28442.07	310
15/1823.22	238	15/2216.07-22	162	16/2302.22-09	33										

Dimmsteuerung mit externen Dimmern

Sofern in unseren Produktbeschreibungen als „dimmbar“ gekennzeichnet, sind unsere LED-Leuchten zum Betrieb an externen LED-Dimmern geeignet.

Nachfolgende Tabelle zeigt die von uns getesteten Kombinationen unserer Leuchten und Dimmern eines ggf. vorhanden Schalterprogramms. Bitte beachten Sie, dass evtl. durch den Betrieb an externen Dimmern auftretende Brummgeräusche nicht auszuschließen sind.

Dimming with external dimmers

If specified in our product descriptions as "dimmable" our LED-luminaires can be operated with external LED-dimmers.

The list below shows the result of the tested combinations of luminaires and possibly existing dimmers. Please kindly note that external dimmers may cause buzzing noise.

	Busch-Jäger		Gira		Jung		Vadsbo	
	Drehdimmer rotary dimmer 6523 UR-102	Tastdimmer push dimmer 64851 U	Drehdimmer rotary dimmer LED 2455 00	Tastdimmer push dimmer LED 2385 00	Drehdimmer rotary dimmer 1731 DD	Tastdimmer push dimmer 1710DE LED	Drehdimmer rotary dimmer VD300	Tastdimmer push dimmer LD220
ADEO 18/1807	•	•	•	•	•	•	•	•
15/2409		•	•	•	•	•	•	•
BELOS 45/2309, 45/2319	•	•	•	•	•	•	•	•
65/2309		•	•	•	•	•	•	•
BORA 15/1745		•	•	•	•	•	•	•
25/2402		•	•	•	•	•	•	•
CHAZ 18/2402		•	•	•	•	•	•	•
CITA 16/2306		•	•	•	•	•	•	•
16/2403		•	•	•	•	•	•	•
CLAIR 36/2403	•	•	•	•	•	•	•	•
COPA 16/2302		•	•	•	•	•	•	•
COR 18/2116		•	•	•	•	•	•	•
15/1905, 15/1906, 18/2005	•	•	•	•	•	•	•	•
COSI 15/1907		•	•	•	•	•	•	•
18/2006		•	•	•	•	•	•	•
DEX 18/2035	•	•	•	•	•	•	•	•
EIGHT 16/2214, 66/2313		•	•	•	•	•	•	•
ENIO 15/2215, 15/2216, 15/2415		•	•	•	•	•	•	•
16/2001	•	•	•	•	•	•	•	•
FLUTE 36/2002		•	•	•	•	•	•	•
GOTO 15/2013		•	•	•	•	•	•	•
HELEN 18/2410		•	•	•	•	•	•	•
INEO 15/2303	•	•	•	•	•	•	•	•
IVA 15/2041	•	•	•	•	•	•	•	•
KAIROS 66/2307		•	•	•	•	•	•	•
KAPO A18610	•	•	•	•	•	•	•	•
KARI 15/1945, 15/1946		•	•	•	•	•	•	•
KEA 66/2108	•	•	•	•	•	•	•	•
LEXX 16/1504, 16/1644		•	•	•	•	•	•	•
LICA 15/2210	•	•	•	•	•	•	•	•
15/2211	•	•	•	•	•	•	•	•
15/1632		•	•	•	•	•	•	•
LIV 15/1732		•	•	•	•	•	•	•
25/1734, 26/1692, 26/1792		•	•	•	•	•	•	•
26/1892		•	•	•	•	•	•	•
LOMO 15/1800, 15/1900		•	•	•	•	•	•	•
LOOPY 16/2109		•	•	•	•	•	•	•
METIS 96/2311		•	•	•	•	•	•	•
MOYA 16/1722	•	•	•	•	•	•	•	•
NEX 16/2007		•	•	•	•	•	•	•
OKI A18803		•	•	•	•	•	•	•
OSO 15/1552, 15/1553	•	•	•	•	•	•	•	•
PALA 15/1629		•	•	•	•	•	•	•
PAX 15/1808	•	•	•	•	•	•	•	•
25/1808	•	•	•	•	•	•	•	•
PINA 16/2314		•	•	•	•	•	•	•
POLE 36/1901, 46/1901		•	•	•	•	•	•	•
PONT 25/2080		•	•	•	•	•	•	•
15/1954		•	•	•	•	•	•	•
RACK 15/1956	•	•	•	•	•	•	•	•
15/2254	•	•	•	•	•	•	•	•
RIWA 15/1806	•	•	•	•	•	•	•	•
35/1806	•	•	•	•	•	•	•	•
ROMO 16/2404		•	•	•	•	•	•	•
15/1964		•	•	•	•	•	•	•
ROTA 25/1964		•	•	•	•	•	•	•
15/2164		•	•	•	•	•	•	•
SALLY 26/1641		•	•	•	•	•	•	•
SAO 25/2330, 25/2331, 26/2430, 26/2431, 28/2330		•	•	•	•	•	•	•
SID 15/2034	•	•	•	•	•	•	•	•
SIMO 75/2212		•	•	•	•	•	•	•
115/2212		•	•	•	•	•	•	•
SIRI44 A28242, A28342	•	•	•	•	•	•	•	•
SIRI44-L A28442	•	•	•	•	•	•	•	•
SKA 15/2012	•	•	•	•	•	•	•	•
SKIP A18805		•	•	•	•	•	•	•
15/1993		•	•	•	•	•	•	•
SONA 25/1994		•	•	•	•	•	•	•
SWIFT A28704	•	•	•	•	•	•	•	•
TAIL 28/2114		•	•	•	•	•	•	•
VIRTO 15/2416, 15/2417		•	•	•	•	•	•	•



Lichtsteuerung über Smartphone/Tablet-PC und Wandschalter

Alle mit diesem Symbol gekennzeichneten LED-Leuchten können optional mit einem Casambi Bluetooth-Modul ausgestattet werden. Die Leuchte kann dann mit der Casambi App für iOS und Android Geräte und/oder mit herkömmlichen Wandschaltern gesteuert werden. Die Casambi App ist kostenlos im Apple App Store und im Google Play Store erhältlich.

- Steuerung der Leuchte/n mit der App oder vorhandenem Wandschalter
- Dimmen der Leuchte/n
- Erstellen von Lichtszenen und Animationen
- Timerfunktion für zeitbasiertes an- und abschalten
- Netzwerkkonfiguration für mehrere Smartphones/Tablet-PC

Lighting control with smartphone/tablet-PC and wall switch

All luminaires marked with this icon can be equipped with an additional Casambi Bluetooth-dimmer. The Luminaire can be controlled with Casambi App for iOS and Android devices, as well as with standard wall switches. The Casambi App is available free of charge from Apple App Store and Google Play Store.

- lighting control with App or existting wall switch
- dimming of luminaire/s
- creating of lighting scenes and animations
- turn on and off with timer function
- network configuration for several smartphones/Tablet-PC

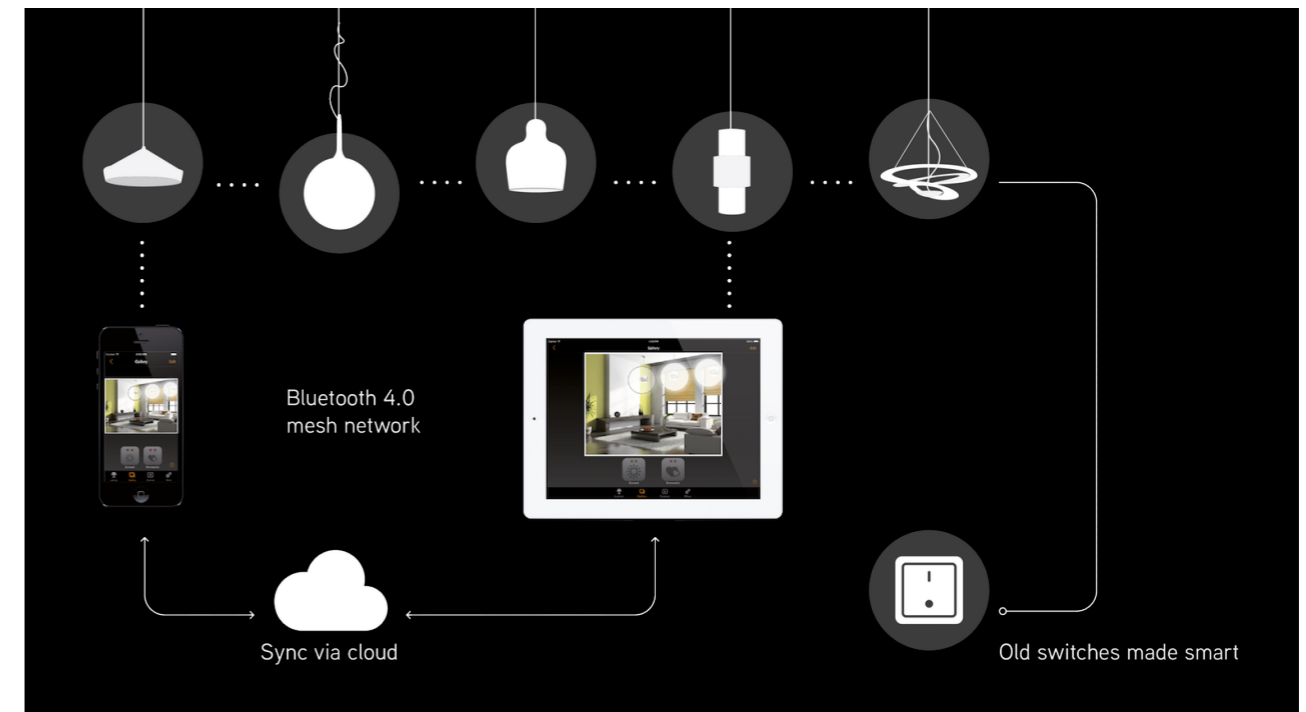

Bestellen Sie das Casambi Bluetooth-Modul gemeinsam mit der gewünschten Leuchte. Wir optimieren mittels Software das Dimmverhalten unserer Leuchten und liefern das Modul anschlussfertig in der Leuchte integriert.

Order the Casambi Bluetooth-dimmer together with the desired luminaire. We optimize the dimming behaviour of our luminaires by software and supply the module integrated in the luminaire.

Art-Nr. 6100

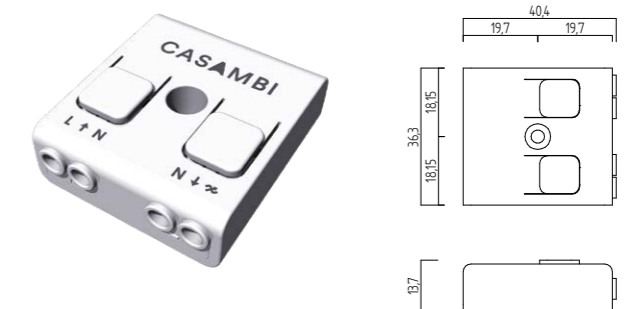



Die unsichtbare Höhenverstellung exklusiv von Helestra

- intuitives Verschieben der Leuchte auf gewünschte Höhe ohne Gegengewicht
- geeignet für unterschiedlichste Raumhöhen durch extra großen Verstellbereich von ca. 500-1700 mm
- kein Kürzen überstehender Leitungen bei niedrigen Raumhöhen durch automatische Kabelaufnahme im Gehäuse
- ideal an schrägen Decken durch unabhängige Verstellung beider Kabel
- einfache und schnelle Montage der Gehäuseabdeckung mit Magnetbefestigungen ohne sichtbaren Schrauben
- werkzeuglose Einstellung des Zugwiderstands

The invisible height adjustment exclusively by Helestra

- intuitive adjustment of desired height without counterweight
- suitable for various ceiling heights due to extra large adjustment range of about 500-1700 mm
- no shortening of unused cable at low ceilings – cables are stored in the housing
- ideal for sloped ceilings because of individual adjustment of cables
- quick and easy installation of housing cover with magnets. No visible screws
- tool-free adjustment of tensile strength



unsichtbar integriert im Deckengehäuse

invisibly integrated in ceiling housing

IP

Schutzzonen im Bad IP ratings and zones for bathrooms

Zone 0
≥ IPx7

Schutz gegen Untertauchen
Innenbereich Badewanne und Duschtasse
protection against immersion
inside bathtub or shower

Zone 1
≥ IPx5

Schutz gegen Strahlwasser
Senkrechte Flächen über Badewanne und
Duschtasse bis zu 2,25 m Höhe
protection against hose water
vertical surfaces above bathtub or shower
up to height of 2.25 m from the floor

Zone 2
≥ IPx4

Schutz gegen Spritzwasser
Bereich von 0,60 m um Zone 1
protection against splash water
0.60 m outside the perimeter of zone 1



Bitte beachten Sie:

Alle angegebenen Maße sind ca.-Abmessungen. Technische Änderungen behalten wir uns vor.

Bitte beachten Sie die der Leuchte beigefügten Gebrauchs- und Montageanleitungen.

Helestra Leuchtenmodelle sind als Geschmacksmuster geschützt, Nachahmungen werden gerichtlich verfolgt.

Das Eigentumsrecht dieses Kataloges behalten wir uns vor.

Es gelten grundsätzlich nur unsere Verkaufs- und Lieferbedingungen. Erfüllungsort und Gerichtsstand ist Dresden.

Please kindly note:

The measurement specifications refer to approximate dimensions. Technical details are subject to change.

Please pay attention to instructions of use and assembly provided with the luminaires.

Helestra products are protected by design registrations, imitations will be prosecuted.

We reserve ownership rights to this catalogue.

As a rule, only our sales and supply conditions apply. Place of delivery and jurisdiction is Dresden.



light+building
Frankfurt, Germany
03.03.2024 – 08.03.2024

Copyright

Helestra Leuchten GmbH
An den Breiten 7
D-01454 Leppersdorf
Tel. +49 (0) 35 28 / 43 83-0
Fax +49 (0) 35 28 / 43 83-44
www.helestra.de
info@helestra.de
USt.-Id: DE140207452
WEEE-Nr.: DE34965681
LUCID-Nr.: DE1937740317474

Fotografie
Photography
Klaus Stoll GmbH
D-59759 Arnsberg
Printed in Germany



Helestra Leuchten GmbH
An den Breiten 7
D-01454 Leppersdorf
Tel. +49 (0) 35 28 / 43 83-0
Fax +49 (0) 35 28 / 43 83-44
www.helestra.de
info@helestra.de



www.helestra.de